

digital

s/gen

advanced monitor  
utility program

digital equipment corporation

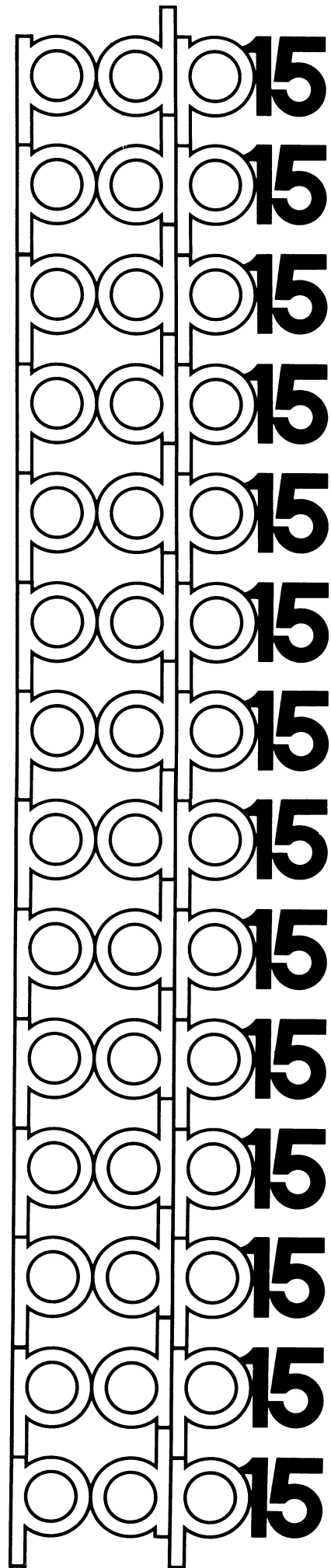



DEC-15-YWZA-DN3  
UPDATE #3 TO PDP-15  
UTILITY PROGRAMS MANUAL

SGEN  
SYSTEM GENERATOR  
UTILITY PROGRAM

NOTE

THIS MANUAL IS A COMPLETE REPLACEMENT FOR THE SGEN  
SECTION OF THE PDP-15 UTILITY PROGRAMS MANUAL  
PRINTED OCTOBER 1969.

FOR ADDITIONAL COPIES, ORDER No. DEC-15-YWZA-DN3 FROM PROGRAM LIBRARY  
DIGITAL EQUIPMENT CORPORATION, MAYNARD, MASSACHUSETTS 01754

PRINTED SEPTEMBER 1970

COPYRIGHT (C) 1970 BY DIGITAL EQUIPMENT CORPORATION

THE MATERIAL IN THIS MANUAL IS FOR INFORMATIONAL  
PURPOSES AND IS SUBJECT TO CHANGE WITHOUT NOTICE.

THE FOLLOWING ARE TRADEMARKS OF DIGITAL EQUIPMENT CORPORATION,  
MAYNARD, MASSACHUSETTS:

DEC

FLIP CHIP

DIGITAL

PDP

FOCAL

COMPUTER LAB

## PREFACE

The System Generator (SGEN) program described in this manual may be used only with the V5A or later versions of the Advanced Monitor Software System for PDP-15/20/30/40 configurations.

### To New Users

The SGEN program provides the user with the means to rapidly tailor the general-purpose ADVANCED software system provided by Digital into a system optimized for his particular needs.

### Prerequisite

In the preparation of this manual, it was assumed that the reader is familiar with the Advanced Software System; e.g., its Monitor and Utility programs, etc.

PDP-15/20/30/40 ADVANCED MONITOR SOFTWARE SYSTEM MANUAL, DEC-15-MR2B-D

This manual provides descriptions of system programs including discussions of: languages, utilities and application, operation, core organization, and input/output operations within the Monitor environment.

PDP-15 UTILITY PROGRAMS MANUAL, DEC-15-YWZB-D

The PDP-15 Utility Programs manual is comprised of a set of individual manuals, each of which describes the operation and use of a PDP-15 Utility Program. The manuals which make up the Utility Programs set are listed in the following Application Guide. In addition, the guide also indicates the order number of each manual and the specific PDP-15 Monitor Software Systems in which the program described may be used.

The Utility Manuals may be ordered either individually, by using the title and order number given with each manual or as a set by referencing "PDP-15 Utility Programs Manual, DEC-15-YWZB-D".



APPLICATION GUIDE

PDP-15 Utility Program Manuals and the Application of Each

Manual		Applies to Monitor:			
Title	Order Number (DEC-15-YWZB- )	DOS	ADV	B/F	BASIC I/O
DDT Utility Program	DN1	✓	✓	✓	✓
CHAIN & EXECUTE Utility Program	DN2	✓	✓	✓	✓
SGEN ADVANCED Monitor	DN3		✓		
MTDUMP Utility Program	DN4	✓	✓		✓
PATCH Utility Program	DN5	✓	✓	✓	
EDIT Utility Program	DN6	✓	✓	✓	✓
UPDATE Utility Program	DN7	✓	✓	✓	
LINKING LOADER	DN8	✓	✓	✓	✓
PIP ADVANCED Monitor	DN9		✓	✓	✓
PUNCH Utility Program	DN10				✓
SRCCOM Utility Program	DN11	✓	✓	✓	
SGEN DOS Monitor	DN12	✓			
PIP DOS Monitor	DN13	✓			
Disk SAVE/RESTORE Programs	DN14	✓	✓	✓	

## To Users Familiar with Previous Versions of SGEN

This new SGEN program provides the user with greater power and flexibility in the generation of new systems and, as a major new feature, permits the straightforward and rapid modification of existing systems. In modifying an existing system, the user may alter:

- (1) API and Teletype usage,
- (2) system I/O devices and device handlers,
- (3) the contents and order of the system Skip Chain,  
and
- (4) the system .DAT slot assignments.

The new features offered by SGEN in the generation of new systems include:

1. The complete deletion of all unwanted device handlers or system programs from new systems.
2. The ability to add user programs to the new system as system programs.
3. The optional addition of a system ↑Q core dump area.
4. The ability to re-order system programs and to specify the actual length of the system (specified in 400<sub>g</sub>-word blocks). These capabilities permit the optimization of program loading times for DECTape systems.



## CONTENTS

### SECTION 1

#### INTRODUCTION

1.1	System Generator	1-1
1.2	SGEN, Basic Units and Features	1-1
1.2.1	SGEN Program Unit	1-1
1.2.2	.SGEN2 Program Unit	1-2
1.2.3	.SGEN3 Program Unit	1-2
1.3	SGEN Operations	1-3
1.3.1	Pre-operational Considerations	1-3
1.3.1.1	New System Size	1-3
1.3.1.2	Calculating $\uparrow$ Q Area	1-5
1.3.1.3	MACROI and F4I	1-5

### SECTION 2

#### SYSTEM GENERATION STEP-BY-STEP PROCEDURE

2.1	Contents	2-1
2.1.1	Procedure Notes and References	2-1
2.1.2	Procedure Headings	2-1
2.1.3	Conventions Used in Procedure	2-1
2.2	Preparatory Device/.DAT Slot Assignments	2-3
2.2.1	New Systems	2-4
2.2.2	Updating Old Systems	2-4
2.3	Step-by-Step Procedure	2-4

### SECTION 3

#### SGEN OPERATIONS, SPECIAL CONSIDERATIONS

3.1	Contents	3-1
3.1.1	Single Vs. Multi-System Users	3-1
3.2	Selection of Responses	3-1
3.2.1	CORE SIZE (8, 12, 16, 20, 24, 28, OR 32K) [XX]	3-1
3.2.1.1	4K ON/OFF Switch	3-2
3.2.2	API?	3-2
3.2.2.1	API ON/OFF Switch	3-2
3.2.3	$\uparrow$ Q AREA? ( )	3-3
3.2.4	EAE? ( )	3-3
3.2.5	DELETE DISCARDED HANDLERS FROM .LIBR?	3-4
3.2.6	MAX. SYSTEM BLOCK # [1Ø77]	3-4
3.2.7	33TTY? ( )	3-5
3.2.7.1	33 TTY ON/OFF Switch	3-5
3.2.8	Deletion/Addition of I/O Devices and Handlers	3-5
3.2.8.1	DEV NAME	3-6
3.2.8.2	NEW HANDLERS	3-6
3.2.8.3	SKIP IOTS	3-6

3.2.9	B. DISPLAY SKIP CHAIN?	3-7
3.2.10	CHANGE SKIP CHAIN ORDER?	3-7
3.2.10.1	Use of ALTMODE in Re-ordering New System Tables	3-8
3.2.11	C. DISPLAY .DAT SLOTS?	3-8
3.2.12	ALTER .DAT SLOTS:	3-9
3.2.13	D. CHANGE SYS PROG?	3-9
3.2.14.1	Adding F41 and MACROI Programs to an 8K System	3-11
3.2.15	ADD SYS PROG.?	3-12
3.2.15.1	PROG. NAME (6 OR LESS ALPHANUMERICS)	3-12
3.2.15.2	# OF DEVICE BLOCKS	3-12
3.2.15.3	.DAT SLOTS (-15 to 10 OR ALL):.	
3.2.16	E. DISPLAY PROG ORDER	3-13
3.2.17	DELETE RELOCATABLE FILES?	3-13
3.2.18	CHANGE PROG. ORDER	3-13
3.3	Optimal Loading of System Programs	3-14

Appendix A	SGEN Error Messages	A-1
------------	---------------------	-----

Appendix B	Example, Generation of an Optimized 8K DECTape System	B1
------------	---	----

Figure 1-1	SGEN Operations, Information Flow Diagram	1-4
------------	---	-----

Figure 3-1	8K System Tape Allocations	3-16
------------	----------------------------	------

Table 2-1	Step-by-Step Procedure	2-5
-----------	------------------------	-----

## SECTION 1

### INTRODUCTION

#### 1.1 SYSTEM GENERATOR

A general-purpose ADVANCED Monitor software system is supplied with each PDP-15 configuration which includes some form of mass storage (e.g., DECTape or DECdisk) and DECTape or magnetic tape for backup. A system Generator program (SGEN), provided as part of the general-purpose package, enables the user to tailor and add to the supplied software in order to develop a resident software system unique to the installation or to his specific needs.

The general-purpose software is normally supplied to the PDP-15 user on a DECTape. This general-purpose DECTape contains all of the standard PDP-15/20 System Programs, Utility Programs, and I/O device Handlers supplied and supported by DEC; it should never be modified, as permitted by SGEN, but should be maintained as a master reference tape.

#### 1.2 SGEN, BASIC UNITS AND FEATURES

SGEN provides the user with two basic capabilities:

- 1) it may be used to modify an existing software system (see 1.2.1),
- 2) it may be used to generate a new (specialized) system from either the master general-purpose system or a previously generated system (see 1.2.2 and 1.2.3).

The SGEN program is divided into three units entitled SGEN, .SGEN2, and .SGEN3. During system generation the three program units are loaded into core in sequence with each succeeding unit overlaying the resident unit. Only the first unit, SGEN, is required in the modification of an existing software system; all three units are required in the generation of a new software system.

##### 1.2.1 SGEN Program Unit

This program unit enables the user to alter or to determine system parameters for I/O devices, Device Handlers, .DAT slots and Teletype<sup>1</sup> and API usage. The SGEN unit features include 1) enabling the user to specify many handlers for one device, 2) the formation of a new skip chain by referencing one on an existing system, and

<sup>1</sup>Teletype is the registered trademark of the Teletype Corporation.

3) the alteration of .DAT slot assignments using standard monitor assign commands. The modification of an existing software system is terminated on the completion of this program unit.

### 1.2.2 .SGEN2 Program Unit

In the development of a new software system, unit .SGEN2 is called into core by and overlays the SGEN unit on completion of its operations. The capabilities offered by .SGEN2 are related to SYS file<sup>1</sup> programs, the system control Q (↑Q) area, the system SYSBLK area and the system monitor commands (in SKPBLK). Program unit .SGEN2 allows the user to:

- 1) delete the ↑Q area from the new system,
- 2) delete SYS file system programs,
- 3) set up file storage and control areas in the new system for the addition of new SYS file programs to the system.
- 4) permit the re-ordering of the location of the SYS files on the new system medium.

The system directory of the new system to be generated is automatically updated during .SGEN2 operations to include the names and starting block numbers of all SYS files to be included in the new system.

### 1.2.3 .SGEN3 Program Unit

The .SGEN3 program unit is called into core by and overlays unit .SGEN2 on completion of its operations. The capabilities provided the user by the .SGEN3 unit include:

- 1) the ability to delete from the system library (.LIBR BIN) the program units of user-deleted handlers (.SGEN2 operation);
- 2) the ability to update the desired versions of the Object Time System (OTS) REAL and INTEGER software routines (EAE or non-EAE) into the new system library;
- 3) the ability to transfer selectively the relocatable files contained by the Old System input source into the new system.

During the operations of this program unit, version C of the system device handler is automatically relocated and placed into the correct area of the new system. On completion of the .SGEN3 program unit, the nonresident monitor is called back into core.

<sup>1</sup>SYS files are system programs which are loaded by the entry of a unique keyboard command. The file name extension "SYS" identifies these files.

### 1.3 SGEN OPERATIONS

In order to develop a new system (see Figure 1-1) the System Generator program requires:

- 1) a "current" operating system from which the monitor and the required program units of the SGEN program may be loaded;
- 2) an "old System" input source from which the "current" system can obtain inputs required to construct the new system;
- 3) a "new system" output device on which to build the desired system.

In many cases, both the "current" and the "Old" systems may be the same system; for example, when a new system is being generated from the Master DECTape supplied by Digital, all required inputs may be obtained from the single master source.

The operations of the System Generator are carried out on an interactive program/user basis via program printouts and user keyboard inputs. A step-by-step procedure illustrating the program printouts and required user responses for the System Generator operations is given in Section 2.

System generation may be carried out from DECTape to DECTape, DECTape to DECdisk, DECdisk unit to DECdisk unit, and DECdisk unit to DECTape.

#### 1.3.1 Pre-Operational Considerations

Careful planning is necessary to ensure that the most efficient system will be developed for the user's particular needs. Some items to be considered in the pre-operational planning of a new system generation are described in the following paragraphs.

##### 1.3.1.1 New System Size --

The size of the system to be developed must be calculated to determine if it will fit the selected output device. The maximum length, in  $400_8$ -word blocks, for systems on DECTape or DECdisk are:

- 1) DECTape --  $1100_8$  blocks ( $\emptyset - 1\emptyset77_8$ )
- 2) DECdisk --  $1000_8$  blocks ( $\emptyset - 777_8$ )

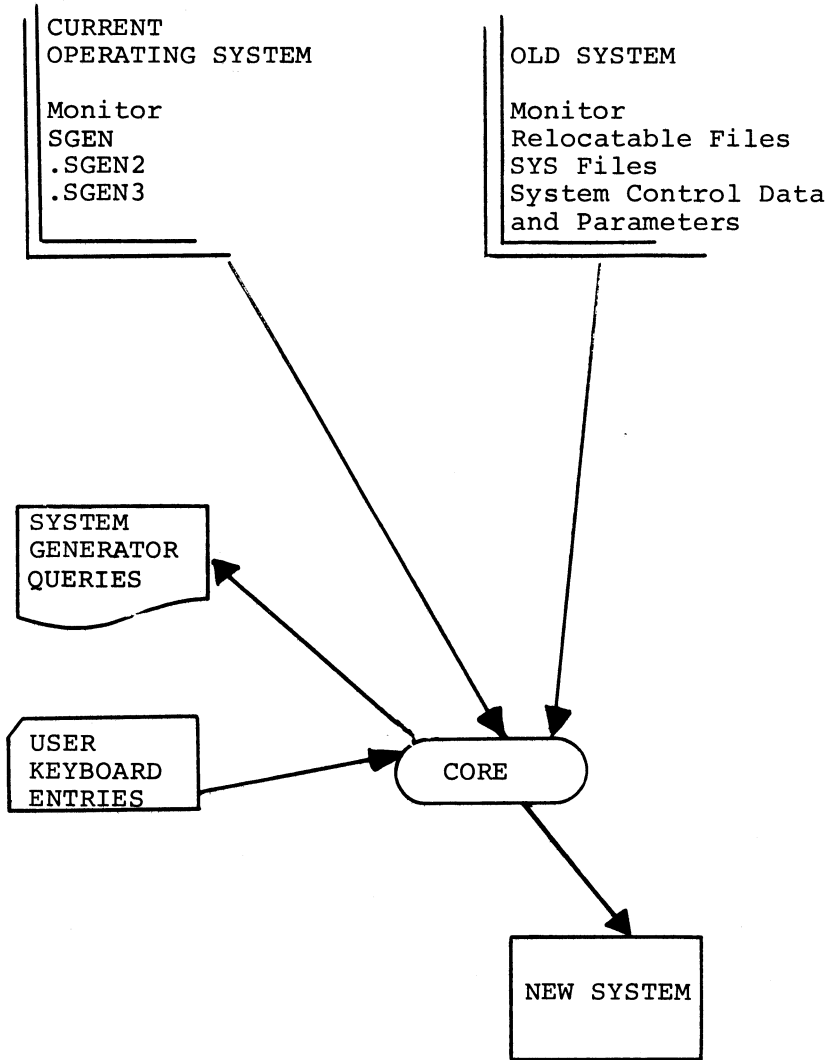

Figure 1-1. SGEN Operations, Information Flow Diagram

One procedure which could be used to determine the number of free system blocks available for adding programs would be to:

1. Call PIP and obtain a directory listing using the PIP "L" command. This will give the number of free system blocks, the number of SYS file blocks, and the name and number of blocks occupied by each relocatable file.
2. Call PATCH and obtain the size of each SYS file through the use of the PATCH "NB" command. Using the NB command (e.g., [SYS file name] NB ) for each SYS file named in the monitor directory will give the size in blocks of the system area allotted to each SYS file.

If MACROI and F4I programs are present on the "Old System" and the new system is to have a core size larger than 8K, an additional 100<sub>8</sub> system blocks will be freed by the automatic deletion of these programs (40<sub>8</sub> blocks apiece).

If a system without a ↑Q area is used as the Old System, the size of the ↑Q area for the new system, if desired, must be subtracted from the number of free blocks in the old system in order to determine the number of blocks available for additional programs (e.g., Master tapes distributed by DIGITAL do not contain ↑Q areas).

#### 1.3.1.2 CALCULATING ↑Q AREA

The System Generator will reserve 20<sub>8</sub> blocks for each 4K of core specified by the user as the ↑Q area. A smaller ↑Q area than core size would result in the loss or clobbering of system files if a ↑QØ command is given. A system with no ↑Q area will not allow a ↑QØ command to be executed, but will wait for another unit number.

#### NOTE

The deletion of the ↑Q area from a system prohibits the use of the ↑QØ command but does not remove the ↑Q function from the system. Core images may be dumped onto any non-zero (non-system) device by the use of the ↑Q command (e.g., ↑QØ cannot be used, however, ↑Q1 can).

#### 1.3.1.3 MACROI AND F4I

The MACROI and F4I programs supplied on the Master DEctape are special programs intended for use in 8K systems only. Since these are special programs, they do not reside in the same areas as the standard system programs (SYS files) nor is the control data associated with MACROI and F4I contained within the system in the same manner as for standard SYS files.

During the generation of systems larger than 8K, MACROI and F4I are automatically deleted from the new system. The new system, however, will contain the control data associated with these programs.

During the development of 8K systems the user is permitted to optionally add either or both of these special programs to the new system. The optional "ADD" feature causes the areas of the new system medium, which would normally be occupied by the added program unit(s), to be reserved and protected. If the "Old System" being used in the generation procedure contains MACROI and F4I, these programs (if added) are installed into their reserved areas during the last phase of the system generation. If the Old System does not contain MACROI and/or F4I, special procedures (described in 3.14.1) must be performed to install either or both of these programs into the new system.

If the procedures described in Section 3 are not followed an 8K system will be generated which will respond to load commands for either of these programs by: 1) loading unknown data (garbage) from the area reserved for but not containing the called program, and 2) attempting to execute the unknown data.



## SECTION 2

### SYSTEM GENERATION, STEP-BY-STEP PROCEDURE

#### 2.1 CONTENTS

A complete step-by-step system generation procedure is presented in this Section. The procedure itemizes and describes each possible operation. Teletype printouts of the System Generator outputs and user inputs are also illustrated where applicable.

##### 2.1.1 Procedure Notes and References

Where necessary, examples and notes (both directive and explanatory) are given in the procedure itself. Paragraph references are given in the procedure for supplementary data contained by Section 3 "SGEN OPERATIONS, SPECIAL CONSIDERATIONS".

##### 2.1.2 Procedure Headings

The column headings used in the tabular procedure format and the meaning of each are as follows:

1. ITEM - reference number.
2. PROCEDURE - a description of each SGEN Program printout made and the required user response is given in this column.
3. PRINTOUT - a typed representation of the actual Teletype printout of each output is given in this column. Normally, printouts are printed on a single line; however, manual page format space restrictions require the longer messages to be illustrated on two or more lines.
4. REFERENCE - paragraph numbers which identify detailed descriptive data, normally concerning the selection of a response, are presented in this column.

##### 2.1.3 Conventions Used in Procedure

The following conventions are used throughout the SGEN Program procedure:

1. Query printouts terminated in a ? require either Y (yes) or N (no) response from the user.

- a. The ? symbol may be followed by parentheses containing the response (Y or N) given in the generation of the old system. For example, the printout

7 CHANNEL MAGTAPE (Y)

indicates that the old system response had been Y (yes).

- b. In BATCH mode, all Y or N user responses MUST be terminated by a ↵(CRLF) entry.
2. In the SGEN Program, procedures incorporating information from an old system and which require a response different from Y or N may be followed by a set of brackets [ ] containing the old system response. (The bracketed symbols represent the response given during the generation of the old system.)

For example, the printout

MAX. SYSTEM BLOCK # [1077]

requests the entry of the number of the system block which is to contain the last information to be stored on the tape; the number [1077] indicates that the old system response had been number 1077.

3. SGEN Program queries which require or provide for a multiresponse are formatted as follows:

<u>FORMAT</u>	<u>EXAMPLE</u>
(a) Message terminated in a colon is printed	NEW HANDLERS:
(b) CR,LF is performed and an angle bracket is printed	>

The user responds by entering the needed responses, one response per line ( > is echoed<sup>1</sup> at start of each line until all entries are made<sup>1</sup>. The response series is terminated by entering (after > ) the word DONE or, in a non-Batch mode, a single ↵.

For example:

NEW HANDLERS:

>DRA

>DRB

>DONE (or ↵)

4. An ALT MODE response is echoed by the Teletype as a dollar sign \$.

NOTE: ALT MODE responses are not permitted in Batch mode.

<sup>1</sup>NOTE: IF a > is preceded by X (i.e., 'X >') then preceding line was in error (ignored).

5. SGEN Program operations are divided into five sections identified by the letters A., B., C., D., and E., which appear as the first letter in the printout which introduces the section. A control P (↑P) command issued at any time within any section of SGEN returns the procedure to the first statement of that section. This sectionalization of the SGEN programs with respect to the user of the ↑P command enables the user to correct any mistakes made within a section rather than requiring the entire procedure to be repeated. The ITEMS of the following procedure at which the SGEN program sections are introduced are:

Section A.	ITEM 12
Section B.	ITEM 23
Section C.	ITEM 26
Section D.	ITEM 27
Section E.	ITEM 28

6. Printout operations may be terminated line by line by the entry of a control U (↑U); the printout will be terminated on the line and character printed at the time of entry, and the next line will be output (if one exists). Individual characters may be deleted (erased) from an input by using the Rubout (echoes \ symbol for each character deleted).
7. The representative printouts illustrated under the column "PRINTOUT" use the following conventions:

- a) Required user inputs are indicated as underlined areas. For example:

NEW SYSTEM?    (The underlined area indicates that the user response should be entered at that point)

- b) Unknown numeric values are indicated by the letters "XX". For example:

↑Q AREA SIZE [XX]          (user response)  
 (unknown numeric value)

## 2.2 PREPARATORY DEVICE/.DAT SLOT ASSIGNMENTS

The .DAT slot assignments which must be made for the generation of a new system and the updating of an old system are given in the following paragraphs.

### 2.2.1 New Systems

The generation of new systems requires the following assignments:

- |     |            |   |
|-----|------------|---|
| -14 | Old system | The old system does not have to be the current system; however, both systems must be V5A or later systems (current system means the system being used).   |
| -15 | New system | The device on which the new system is to be generated must be assigned to this .DAT slot. The contents of this device medium are ignored and overwritten. |

In 8K, when generating a new system onto a device different from the old system device, the A<sup>1</sup> handler should be assigned the old system device, and the E<sup>1</sup> handler assigned for the new device. The handlers must be assigned in this manner since two device A handlers and the SGEN program cannot fit into 8K of core.

EXAMPLE: The following is an example of the device handler and .DAT slot assignments which are made in a typical DECTape system SGEN operation.

<u>Device</u>	<u>Handler and Unit</u>	<u>.DAT slot</u>
Old System	DTA1	-14
New System	DTA2	-15

### 2.2.2 Updating Old Systems

In updating old systems, the device assigned to .DAT slot -15 is ignored and the system contained by the device assigned to .DAT-14 is modified. In this type of operation:

- 1) .DTA-15 should be assigned to same device as .DAT-14
- 2) When updating, the device on -14 must be WRITE ENABLED.

### 2.3 STEP-BY-STEP PROCEDURE

The operations which may occur in the use of the ADVANCED Monitor System Generator are given in the following table.

<sup>1</sup>Refer to the ADVANCED Monitor manual for a description of the available Device handlers.

Table 2-1 Step-by-Step Procedure

ITEM	PROCEDURE	PRINTOUT	REFERENCE ( )
SECTION 1, SGEN			
1.	Call system generator by typing SGEN	\$SGEN	
2.	Query- Answer <u>Y</u> (yes) or <u>N</u> (no)	NEW SYSTEM ____	
NOTE: If answer given is <u>N</u> (no) sequential operation.			
GO TO ITEM 9A for next			
3.	Query- Answer <u>DK</u> for DECdisk Answer <u>DT</u> for DECTape  Old system device indicated in query brackets.	SYSTEM DEVICE [ ] ____	
4.	Statement describing device assignments (the symbol <input type="checkbox"/> represents device and unit number)	NEW SYSTEM ON <input type="checkbox"/> FROM OLD SYSTEM ON <input type="checkbox"/>	
5.	Query- Select and type in desired system core size or if old system size is OK, enter a (CRLF) only.	CORE SIZE (8, 12, 16, 20, 24, 28, OR 32) [XX]	(3.2.1)
6.	Query- Answer <u>Y</u> (yes) or <u>N</u> (no); answer given in old system is indicated in parentheses.	↑Q AREA? ( ) ____	(3.2.3)
NOTE: If the answer to ITEM 6 is <u>Y</u> , and 12K or more of core has been specified, SGEN will print the following query			
↑Q AREA SIZE [XX] ____			
Enter desired size; if the size in brackets (specified system core size) is acceptable, enter a (CRLF). (The ↑Q area size cannot be smaller than the system core size.)			
7.	Query- Answer <u>Y</u> (yes) or <u>N</u> (no); old system answer indicated in parentheses.	EAE? ( ) ____	(3.2.4)
8.	Query- Answer <u>Y</u> (yes) or <u>N</u> (no)	DELETE DISCARDED HANDLERS FROM .LIBR? ____	(3.2.5)

ITEM	PROCEDURE	PRINTOUT	REFERENCE ( )
------	-----------	----------	---------------

9. Query- MAX. SYSTEM BLOCK # [1077] \_\_\_  
 Enter octal number of block (3.2.6)  
 which is to be the last ac-  
 cessible block in the system.  
 The number within brackets  
 represents the last block in  
 the old system

NOTE: If the SGEN program is to be used to modify an old system  
 (answer to Item 2 is Y), it will print out the following  
 query at this point:

MODIFY SYSTEM ON XXX

where XXX represents the name  
 and unit number identification  
 (e.g., DK1) of the device con-  
 taining the old system.

If the device identification given is not correct, an error  
 was made in preparatory .DAT slot assignments.

10. Query- API? ( ) \_\_\_ (3.2.2)  
 Answer Y or N

11. Query- 33TTY? ( ) \_\_\_ (3.2.7)  
 Answer Y or N

12. Query- A. ALTER I/O DEVICES OR  
 Answer Y or N HANDLERS? \_\_\_ (3.2.8)

NOTE: a. If an N answer is given for ITEM 12, the procedure goes  
 to ITEM 23 for the next sequential operation.

b. If a Y answer is given for ITEM 12, the operations de-  
 scribed in ITEMS 13 through 22 are performed.

THE ENTRY OF ↑P AT ANY POINT IN THESE OPERATIONS RETURNS  
 SGEN TO ITEM 12.

13. Statement, TO BE KEPT: (3.2.8)

NOTE: The statement of ITEM 13 introduces a series of individual  
 multi-line query groups (1 per standard device) which  
 established the devices and device handlers to be kept in  
 the system or added to the system. The following is an  
 example of a device query group (paper tape punch) and  
 instructions as to how the queries are to be handled:

Instruction

Printout

a. Answer Y to keep punch, N to  
 drop punch and skip to next  
 query group

PP? \_\_\_

ITEM	PROCEDURE	PRINTOUT	REFERENCE ( )
b.	Handler Version A. Answer <u>Y</u> to keep, <u>N</u> to drop.	PRA? ___	
c.	Version B, <u>Y</u> to keep, <u>N</u> to drop.	PRB? ___	
d.	Version C, <u>Y</u> to keep, <u>N</u> to drop.	PRC? ___	
e.	Go-Ahead symbol, type in mnemonic of any PP handler to be added. If no more entries, type in <u>DONE</u> or CRLF ( ). Refer to 3.2.8 for a detailed description of how to add handlers here.	> ___	
f.	SGEN prints the skip IOT associated with the device for user convenience.	PSF=700201	

---

NOTE: ITEMS 14 through 21 illustrate the standard query groups normally presented to the user.

---

14.	Paper Tape Reader Query group	PR? ___ PRA? ___ PRB? ___	RSF=700101
15.	Paper Tape Punch Query group	PP? ___ PPA? ___ PPB? ___ PPC? ___ > ___	PSF=700201
16.	DECtape Query group  NOTE: If DECTape is the selected system device, its printout will be formatted as shown for the DECdisk in this procedure (ITEM 17).	DT? ___ DTA? ___ DTB? ___ DTC? ___ DTD? ___ DTE? ___ DTF? ___ > ___	DTDF=707601 DTEF=707561
17.	DECdisk Query group  NOTE: Group format shown here would occur if DK was selected system device, otherwise its format would be the same as shown in ITEM 16.	DK IS SYSTEM DEVICE AND DKC IS SYSTEM HAND  DKA? ___ DKB? ___ DKD? ___ DKE? ___ DKF? ___ > ___	DSSF=707001

ITEM	PROCEDURE	PRINTOUT	REFERENCE ( )
18.	Magnetic Tape	MT? _____ MTA? _____ MTC? _____ MTF? _____ > _____  MTSF=707341	
19.	Line Printer	LP? _____ LPA? _____ > _____  LSDF=706501	
20.	Card Reader	CD? _____ CDB? _____ > _____  RCSF=706701 RCSD=706721	
21.	VP5A Display	VP? _____ VPA? _____ > _____  SDDF=700521	
22.	Query-	ADD NEW DEVICES	(3.2.8)

NOTE: The query of ITEM 22 gives the user an opportunity to include any additional I/O devices and their handlers in the system being developed.

A N (no) answer to the query causes SGEN to go to the operation presented in ITEM 23.

A Y (yes) answer to the query causes SGEN to enter the series of operations given in ITEMS 22a through 22.

DETAILED INSTRUCTIONS ARE NOT GIVEN FOR ITEMS 22a THROUGH 22b; REFER TO REFERENCES PARAGRAPH(S) FOR INFORMATION.

22a.	Query- Enter a unique 2-letter name.	DEV NAME _____	(3.2.8.1)
22b.	Query and go-ahead symbol. Enter handler mnemonics - one per line. Terminate list by entering <u>DONE</u> after symbol.	NEW HANDLERS: > _____ > _____ : > <u>DONE</u> (or )	(3.2.8.2)
22c.	Query and go-ahead symbol. Enter needed skip IOT's for device named in Item 22a. IOT format is:  SKIP = 6-digit octal number MNEMONIC = representing IOT instruction.	SKIP IOTS: > _____ : > <u>DONE</u> (or )	(3.2.8.3)



ITEM	PROCEDURE	PRINTOUT	REFERENCE ( )
------	-----------	----------	---------------

22d. Query- ADD I/O DEVICES?\_\_\_ (3.2.8)

NOTE: The query of 22d. enables the user either to repeat ITEMS 22a through 22c. for the entry of another device, its handlers and its skip IOT's or to exit from this operation and go to ITEM 23.

Answer Y to repeat cycle  
N to exit to ITEM 23.

23. Query- B. DISPLAY SKIP CHAIN?\_\_\_ (3.2.9)  
 A Y answer causes the program to print out the system skip chain as derived from old system tape.

An N answer advances the procedure to ITEM 24.

NOTE: It is advisable to obtain a printout of the skip chain to ensure that all of the desired skip IOT's and only those, are included in the new system. (Refer to paragraph 3.2.9 for more detailed information concerning this operation.)

The following is an example of a Skip Chain printout, the function for each (not printed during System Generation) is also given:

*a) Power Fail	SPFAL
b) DEctape Done Flag	DTDF
c) DECdisk Done	DSSF
d) Mag. Tape Done or Error	MTSF
e) Store, Display Done	SDDF
f) Card Column Ready	RCSF
g) Card Done	RCSD
h) Line Printer Done	LSDF
*i) Clock Done	CLSF
j) Reader Done	RSF
k) Punch Done	PSF
*l) Keyboard Done (TTA)	KSF
*m) Teleprinter Done (TTA)	TSF
n) DEctape Error Flag	DTEF
*o) Non-Existent Memory Ref.	MPSNE
*p) Memory Protect Violation	MPSK
*q) Memory Parity Error	SPE

\*These skips are associated with permanent resident monitor handlers and functions, they will always appear in the Skip Chain unless specifically deleted.

24. Query- CHANGE SKIP CHAIN ORDER?\_\_\_ (3.2.10)  
 Answer Y or N

NOTE: An N answer to ITEM 24 advances the procedure to ITEM 25 for the next sequential operation.

A Y answer to ITEM 24 causes the performance of ITEM 24a.

24a. Statement and go-ahead symbol. In BATCH mode the user must type in -one per line- each SKIP IOT. In Non-BATCH mode the user may enter an ALT MODE command (\$) and the first unused SKIP from the old order is automatically supplied on that line. Terminate list by entering DONE.  
 TYPE NAMES IN NEW ORDER (\$ CAUSES FIRST UNUSED SKIP FROM OLD ORDER TO BE SUPPLIED):  
 > \_\_\_\_\_  
           .  
           .  
           .  
           .  
           .  
 >DONE (or ↵)  
 (3.2.10.1)

25. Special Device questions. The user may have certain optional devices for which additional information is needed. The following ITEMS detail the questions asked in these cases:

25a. 339 Display  
 (1) Query- 339 LOAD DEFAULT LOAD? ( ) \_\_\_\_  
 Answer Y if 339 table is to be included in the monitor.

(2) Query- LOAD VC38 TABLE? ( ) \_\_\_\_  
 Answer Y if a 339 push-down list is to be included in the monitor.

25b. Magnetic Tape: 7 CHANNEL MAGTAPE? ( ) \_\_\_\_  
 The assumption will be 7 channel if Y is typed and 9 channel if N is typed.

25c. Line Printer LINE PRINTER LINE SIZE?  
 Query- (80, 120, OR 132) [XX] \_\_\_\_  
 Answer with the maximum number of characters which may be printed on one line. The number should be one specified in the query.

26. Query- C. DISPLAY .DAT SLOTS? \_\_\_\_  
 Answer Y or N

NOTE: An N answer to ITEM 26 advances the procedure to ITEM 26a for the next sequential operation.

A Y answer to ITEM 26 causes a printout of an ordered list of the current new system .DAT slot assignments and will initiate ITEM 26a.

The following is an example of the Printout of one possible .DAT slot arrangement for a 2 platter RF DECdisk system:

ITEM	PROCEDURE	PRINTOUT	REFERENCE ( )
		-15 DKA2	
		-14 DKAl	
		-13 DKA2	
		-12 TTAØ	
		-11 DKAl	
		-1Ø TTAØ	
		- 6 DKA2	
		- 5 NONE	
		- 4 DKA2	
		- 1 DKAØ	
		1 DKAØ	
		2 DKAl	
		3 DKA2	
		4 TTAØ	
		5 PRAØ	
		6 PPAØ	
		7 DTAl	
		1Ø VPAØ	

26a. Query and go-ahead symbol  
 Answer by entering a reassignment command until all changes are made.  
 Terminate operation by entering DONE

ALTER .DAT SLOTS: (3.2.12)  
 > \_\_\_\_\_  
 .  
 .  
 .  
 .  
 >DONE (or )

Example:

>A DTB1 -13/DT2 1Ø,-6/DT 3  
 >DONE

NOTE: If the procedure was intended for the modification of an Old System (ITEM 2 answered N) the operation would have been completed by the termination of ITEM 26a. The completion of the procedure is indicated by the following printout:

SGEN COMPLETE  
 MONITOR  
 \$

27. Query- Answer Y or N D. CHANGE SYS PROG.? (3.2.13)

NOTE: The query of ITEM 27 permits the user to initiate a cycle of operations during which System Programs may be deleted or added to the group to be installed in the new system.

A Y answer to ITEM 27 initiates the operations presented in ITEMS 27a and 27b. An N answer to ITEM 27 causes the SGEN program to proceed to ITEM 28.

27a. Statement followed by a series of one-per-line queries.  
 Answer queries:  
Y to keep program,  
N to delete program.

TO BE KEPT: (3.2.14)  
 DTCOPY? \_\_\_  
 SRCCOM? \_\_\_  
 F4I? \_\_\_  
 EDIT? \_\_\_  
 EDITVP? \_\_\_  
 MACRO? \_\_\_

TYPICAL EXAMPLE OF PROG. LIST PRINTOUT

PIP? \_\_\_\_\_  
 F4? \_\_\_\_\_  
 SGEN? \_\_\_\_\_  
 DUMP? \_\_\_\_\_  
 UPDATE? \_\_\_\_\_  
 MACROI? \_\_\_\_\_  
 CHAIN? \_\_\_\_\_  
 PATCH? \_\_\_\_\_

NOTE: If an 8K new system is being generated and the Old System does not contain F4I or MACROI, the following statement and queries are made to enable the user to add these files to the new system.

TO BE ADDED: (3.2.14)  
 F4I? \_\_\_\_\_  
 MACROI? \_\_\_\_\_

27b. Query- ADD SYS PROG.? \_\_\_\_\_ (3.2.15)

NOTE: A Y answer to ITEM 27b starts a cycle of queries (ITEMS 27c, d and e) designed to obtain the name, size and .DAT slot assignments of each program to be added. .SGEN returns to ITEM 27b and repeats the cycle until an N answer is obtained.

An N answer advances the SGEN program to ITEM 28.

27c. Query- Answer by entering desired name. PROG. NAME (6 OR LESS ALPHANUMERIC) \_\_\_\_\_ (3.2.15.1)

27d. Query- Answer by entering in octal the number of blocks required to store program. # OF DEVICE BLOCKS [ ] \_\_\_\_\_ (3.2.15.2)

27e. Query and go-ahead symbol. Answer by entering desired .DAT slot assignments; terminate List by entering DONE. .DAT SLOTS (-15 TO 10 OR ALL):  
 > \_\_\_\_\_  
 .  
 .  
 .  
 .  
 >DONE (OR ↵)

28. Query- Answer: Y if a multi-line printout of system program names as they appear in the system is wanted. N if printout is not wanted. E. DISPLAY PROG. ORDER? \_\_\_\_\_ (3.2.16)

NOTE: An example of a System Program Order printout obtained if ITEM 28 is answered Y follows:

ITEM	PROCEDURE	PRINTOUT	REFERENCE ( )
	EDIT		
	EDITVP		
	PIP		
	MACRO		
	CHAIN		
	F4		
	DUMP		
	DTCOPY		
	PATCH		
	UPDATE		
	SRCCOM		
	SGEN		

29. Query- DELETED RELOCATABLE FILES? \_\_\_\_\_  
 Answer: (3.2.17)  
 N if no files are to be  
 dropped; the procedure  
 advances to ITEM 30.  
 Y if changes are to be  
 made; ITEM 29a is per-  
 formed.

29a. Introductory TO BE KEPT:  
 statement FNEW BIN? \_\_\_\_\_  
 followed by first of  
 a list of queries.   
 Queries are to be  
 answered Y to keep  
 file, N to drop file. EXAMPLE

NOTE: The following is an example of the type of file list obtained from ITEM 29a:

Each query must be TO BE KEPT:  
 answered Y to keep  
 named file, or N to  
 delete named file.  
 8TRAN BIN? \_\_\_\_\_  
 FOCAL BIN? \_\_\_\_\_  
 FNEW SRC? \_\_\_\_\_  
 TIME BIN? \_\_\_\_\_  
 TIME1Ø BIN? \_\_\_\_\_  
 FOCAL XCT? \_\_\_\_\_  
 FOCAL XCU? \_\_\_\_\_

30. Query- CHANGE PROG. ORDER? \_\_\_\_\_ (3.2.18)  
 Answer Y or N.

NOTE: A Y answer initiates the operation described in ITEM 30a in which the user is required to list, in desired order, all system programs. An N answer causes the procedure to advance.

30a. Description statement RETYPE PROG. NAMES IN DESIRED  
 and go-ahead symbol. ORDER (\$ CAUSES FIRST UNUSED  
 User must enter names PROG. FROM OLD ORDER TO BE  
 of all programs in- ADDED AT THAT POINT):  
 included in system (one > \_\_\_\_\_ (3.2.10.1)  
 per line) in desired  
 order.

The use of the termin-  
 ator "DONE" is illegal  
 since all SYS file system  
 programs must be included.

ITEM	PROCEDURE	PRINTOUT	REFERENCE ( )
------	-----------	----------	---------------

31.	Statement	SGEN IN PROGRESS (↑ illegal)	
-----	-----------	------------------------------	--

NOTE: The statement of ITEM 31 indicates that the SGEN program is in the process of building the new system onto the assigned output device. The approximate time required for this operation is:

- a) DEctape to DEctape - - - - - 15 minutes
- b) DEctape to Disk - - - - - 10 minutes
- c) Disk to Disk - - - - - 1 minute
- d) Disk to DEctape - - - - - 10 minutes

32a.	Statement and List. A list of the handlers deleted from the new system library (only if ITEM 8 was answered <u>Y</u> ) is output.	DELETED HANDLERS:  CDB.      Example
------	--	--

32b.	Statement and List. A list of all handlers which were not found in the old Library is output.	MISSING HANDLERS:  RFE. } RFF. }      Examples LPA. }
------	--	---

33.	Statement, System Generation complete, new system is on assigned output device medium.	SGEN COMPLETE
-----	---	---------------

## SECTION 3

### SGEN OPERATIONS, SPECIAL CONSIDERATIONS

#### 3.1 CONTENTS

This Section contains descriptions of the various considerations and alternatives of which the user should be aware in selecting his response to many of the queries presented during the System Generation procedure.

##### 3.1.1 Single Vs. Multi-System Users

Much of the information given in this Section is based on the fact that the user is either a:

- 1) Single-System User, has only one PDP-15 system available to him; or is a
- 2) Multi-System User, has more than one PDP-15 system available to him.

These terms, (items 1 and 2) are used throughout this Section.

#### 3.2 SELECTION OF RESPONSES

The selection of the best possible responses to the System Generator queries, which present multi-response situations not necessarily obvious to the user, is the subject of many of the following paragraphs. Each of the following query-response descriptions is entitled according to the specific SGEN query with which it is concerned.

##### 3.2.1 Core Size (8, 12, 16, 20, 24, 28, or 32K) [XX]

Normally single-system users will respond to this query with the actual size of the core contained by their system. One method, however, by which system users may delete the MACROI and F4I programs from their new system is to respond to this query with 16. By specifying a 16K core size, the 8K user causes the automatic deletion of MACROI and F4I; the bootstrap will take care of the system core size at load time.

Multi-system users may be required to run programs on systems having different sized cores. In such cases, the user normal-

ly specifies the core size of the smallest system on which he is required to run. In situations where one or more of the systems used has a core size other than 8K or some direct multiple of 8K (i.e., 16, 24 or 32) the requirement of a 4K ON/OFF switch must be considered.

3.2.1.1 4K ON/OFF Switch - In running a system with an extra 4K of core on a computer not having an extra 4K of core of memory, the user must:

1. Enter command X4K OFF immediately after loading the monitor. THIS COMMAND MUST BE REPEATED EACH TIME THE MONITOR IS RELOADED.

In running a system that does not use an extra 4K of memory on a computer with an extra 4K of memory:

2. Enter command X4K ON immediately after loading the Monitor. THIS COMMAND NEED ONLY BE ENTERED ONCE.

To avoid having to enter the X4K OFF command repeatedly the user should specify during SGEN the size core which is a direct multiple of eight and is equal to or less than the smallest system on which he is to run.

### 3.2.2 API?

Multi-system users who plan to run on both API and non-API systems must consider the required API ON/OFF switch.

3.2.2.1 API ON/OFF SWITCH - The command "API OFF" must be issued to the Monitor when it is loaded by users who run an API system tape on a non-API computer. THIS COMMAND MUST BE REPEATED EACH TIME THE MONITOR IS LOADED.

The command "API ON" should be issued to the Monitor the first time it is loaded by a user who runs a non-API system tape on a computer containing the API option. THIS COMMAND ENABLES THE API OPTION UNTIL THE BOOTSTRAP IS RELOADED.

If both API and non-API computers are to be used, it is recommended that the user answer the SGEN query "API?" with the no "N" response; this will permit him to use the required API ON command thus limiting the number of times which he has to issue the API switch command.



### 3.2.3 ↑Q AREA? ( )

The addition to or deletion from the new system tape of a ↑Q area is determined by this query. The ↑Q area is an area on the system device medium which is designated to receive a core image when ↑QØ is given on the console teletype or in the event of an unrecoverable error. The ↑Q area contains 20<sub>8</sub> blocks for each 4K page of the specified core size. The deletion of the ↑Q area prohibits the use of the ↑QØ command but ↑Q commands to other output devices will still be permitted.

The deletion of this save area would permit the addition of more user programs onto the system tape or would speed the loading of the system programs by reducing the amount of tape which would have to be scanned.

In systems without a ↑Q area, all system programs will load faster (particularly the linking loader and DDT) if:

1. The area freed by the deletion of the ↑Q area is not used for user programs.
2. The user re-specifies the location of the MAXIMUM SYSTEM BLOCK to close up the freed area.

If a ↑Q area is to be included (answer to item 6 is Y) and the core size answer is not 8K<sup>1</sup>, SGEN queries the user as to the desired area size and indicates, within brackets, the default size (i.e., core size):

↑QAREA SIZE [XX] \_\_\_\_\_

The user may specify any size desired as long as it is greater than the default value, or he may accept the default size by entering a CRLF (↵). The multi-system user should specify the core size of the largest system that the new software system is to be used on, otherwise a ↑Q command entered while operating on a larger system will destroy blocks on the system tape.

### 3.2.4 EAE? ( )

The answer to this query indicates to SGEN which version of the FORTRAN OTS REAL and INTEGER packages are to be included

---

<sup>1</sup>NOTE: 8K systems may only have 8K ↑Q areas.

in the system library (.LIBR BIN). A non-EAE system can always work even on a machine with EAE.

To determine if a tape is EAE or non-EAE, without using the .SCOM bit, obtain a listing of the system library with UPDATE L OPTION (.LIBR BIN). The file names of the REAL and INTEGER OTS packages are located near the end of the library and will be:

	RELNON		for non-EAE systems
	INTNON		
or	RELEAE		for EAE systems
	INTEAE		

Besides the bit in .SCOM+4, this is the only difference between EAE and non-EAE systems.

### 3.2.5 DELETE DISCARDED HANDLERS FROM .LIBR? \_\_\_\_\_

A Y answer to this query causes SGEN to delete, completely, from the new system tape library file, any handlers indicated during SGEN operations as unwanted. If an N answer is given, the unwanted handlers remain in the system library but are ignored during system operations (they cannot be used).

A Y answer frees useful device blocks on the system unit medium and speeds up the loading of wanted system programs by eliminating the need to search through unused data during load operations. Once handlers are deleted from the library they are in the same category as user generated handlers which must be added by using the system generator and the library update program.

### 3.2.6 MAX. SYSTEM BLOCK # [1077] \_\_\_\_\_

This SGEN query permits the user to determine the overall length of the system file to be generated onto the new system unit medium by specifying the number (in octal) of the last accessible block in the system. For DECTape the number specified for the maximum-sized system is:  $1077_8$ . For DECdisk the number specified cannot exceed  $777_8$ . For the RB09 Disk the number is  $1077_8$ .

If a DECTape system user has deleted the ↑Q area (see Procedure ITEM 6) and/or intends to discard handlers and/or system programs, he

may close up (shorten) the length of DECTape traversed in loading system programs by specifying a block number less than 1077<sub>8</sub> by the number of unused freed blocks.

The use of this query permits the user to system generate onto system devices which have less than 1100<sub>8</sub> available 400<sub>8</sub>-word blocks (e.g., DECdisk); it also optimizes system loading on the DECTape device by eliminating the need to move tape over blank freed blocks during system program loading.

### 3.2.7 33TTY? ( )

If the system tape being generated is to be used on a computer having a model 33 Teletype unit as an input console device (e.g., PDP-9 systems in a BANK Mode operation) rather than the model 35 unit normally supplied with PDP-15 systems; the use of the Monitor 33TTY ON/OFF switch must be considered.

3.2.7.1 33TTY ON/OFF SWITCH - If the answer to the query of item is Y and the system is being run on a system having a model 35 Teletype unit, the command 33TTY OFF must be issued to the Monitor each time the Monitor is loaded.

If the answer to the query of item is N and the system is being run on a system having a model 33 input device, the command

33TTY ON

must be issued to the Monitor when it is first loaded. THIS COMMAND ENABLES THE 33 TTY OPTION UNTIL THE BOOTSTRAP IS LOADED.

For multi-system users who must employ both models 33 and 35 it is recommended that this query be answered no "N" to limit the number of times that the switch command has to be entered.

### 3.2.8 Deletion/Addition of I/O Devices and Handlers

As indicated in the note of item 13, entire I/O Device Handler groups may be deleted by responding to the device name query with an "N" answer.

A device is also automatically deleted if all of its handlers are deleted. The actual removal of a deleted handler from the new system library file (.LIBR BIN) is determined by the response to item 8.

Any number of handlers may be added to a device.

The names of new device handlers must consist of three characters; the first two characters of a handler name must be the assigned mnemonic of the device for which the handler is intended (e.g., PP\_ for additional paper tape punch handlers). Each handler name must be unique within the system. The last character of a handler name must not be an octal digit.

3.2.8.1 DEV NAME - The new device name entered must consist of two letters, octal numbers cannot be used. New device names cannot duplicate any previously entered names; all future references to the new device must be made using the assigned two-letter mnemonic.

3.2.8.2 NEW HANDLERS - The names of new device handlers must be listed in response to this query (see item 22b). New handlers are named and entered in the same manner as described in paragraph 3.2.8.

3.2.8.3 SKIP IOTS - All skip IOTS associated with the new device must be listed one per line after this query. The format in which the IOTS must be entered is as follows:

[SKIP MNEMONIC] = [6-DIGIT OCTAL NUMBER]

where the octal number represents in octal notation the actual skip instruction. For negative-type skip IOTS, a minus sign must precede the octal number:

[MNEMONIC] = -[OCTAL NUMBER]

The use of negative IOTS is not recommended; if the associated device is down, has been removed from the system, or if the system tape is being used on a system not containing the device, the resulting state of the negative skip whenever the chain is scanned during an interrupt condition, will cause an unrecoverable error (illegal interrupt) if the negative skip is reached before the skip of the device which caused the interrupt.

A listing of the standard device IOTS is given in Appendix A; non-standard device IOTS are assigned as a function of the required hardware interface design.

### 3.2.9 B. DISPLAY SKIP CHAIN?

It is advisable that the user answer this query yes (Y).

Any permanent skips deleted in the generation of the old system are automatically added at the end of the current system skip chain.

If this query is answered Y, the permanent system skips deleted from the old system will appear in the resulting printout near the end of the skip chain list immediately preceding any newly added skips.

The deletion of a permanent (system) skip reduces the size of the resident monitor by 4 words per skip instruction. Teletype skips should never be deleted nor any skips for hardware available in the computer installation.

The following skips are associated with permanent resident monitor handlers and functions and will always appear in the skip chain unless they are specifically deleted. Deletion of the following skips does not remove them from the system generator table; they are only removed from the skip chain itself.

<u>SKIP</u>		<u>FUNCTION</u>
CLSF	= 7000001	Clock Done
MPSNE	= 701741	Non-Existent Memory Reference
MPSK	= 701701	Memory Protect Violation
SPE	= 702701	Memory Parity Error
SPFAL	= 703201	Power Fail
KSF	= 700301	Keyboard Done (TTA)
TSF	= 700401	Teleprinter Done (TTA)

### 3.2.10 CHANGE SKIP CHAIN ORDER?

If the user wishes to change the order of the skip-chain or to delete permanent skips from the skip chain of the new system, this query must be answered Y.

Assuming a Y response, SGEN then requires the user to enter a list of desired skips arranged in the required order (ITEM 24a of the procedure). The entry of this list not only reorders the skip chain but also provides the means of deleting permanent skips from the chain.

Any system skips not entered in the re-ordering operation are dropped from the skip chain.

As a reminder, skips deleted from the skip chain are still within the system and will reappear in the skip chain of any new system generated using this system as the "old system".

### 3.2.10.1 Use of ALTMODE in Re-Ordering New System Tables -

During the re-ordering of Old System SYS file and/or Skip Chain tables for use in the new system being generated, the ALTMODE keyboard input may be used to cause the direct transfer of a table entry from the old system table to the table being developed for the new system. This ALTMODE initiated transfer is a convenience feature which relieves the user of the need to retype all table entries particularly when the new table is to be formed by inserting new items between the items of the existing table.

Each time the ALTMODE key is actuated, the item of the old table immediately following the last transferring item is moved into the next sequential position of the new table. For example: (ALTMODE symbolized by \$):

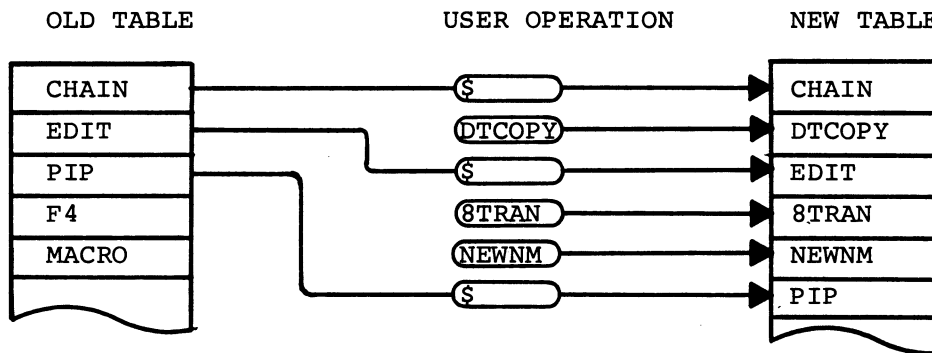

### 3.2.11 C. DISPLAY .DAT SLOTS?

Unless the user is completely familiar with the default .DAT slot assignments (i.e., those of the "Old System") it is advisable that this query be answered Y.

On receiving a Y response, SGEN prints out the default .DAT slot assignment list with the exception of those slots which cannot be changed (i.e., -2, -3, and -7). In the printout, the term NONE is assigned to free or unassigned .DAT slots and those of deleted devices.

### 3.2.12 ALTER .DAT SLOTS:

This SGEN step offers the user the choice of either accepting the default .DAT slot assignments or of altering them.

Acceptance of the default list is accomplished by terminating the operation with a "DONE" entry:

```
ALTER .DAT SLOTS :  
>DONE
```

Reassignment of .DAT slots is accomplished using the standard monitor ASSIGN (A) command (refer to Chapter 4, paragraph 4.3.2.8 of the ADVANCED Monitor manual, DEC-15-MRZA-D for a detailed description of this command). For example:

1) to make a single change in the assignment list such as the assignment of DEctape A handler to DEctape unit 1 on .DAT slot -11 , the following entry is required:

```
ALTER .DAT SLOTS :  
>A DTAl -11,  
>DONE,
```

2) to clear a single .DAT Slot in the default chain, for example, .DAT Slot -11, the following entry is required:

```
ALTER .DAT SLOTS :  
>A NONE -11,  
>DONE,
```

### 3.2.13 D. CHANGE SYS PROG?

If the user wishes either to delete programs from the system or to provide named areas for the installation of a program into the system, this query must be answered yes (Y).

### 3.2.14 TO BE KEPT: (i.e., System Programs)

The function of this procedure is to enable the user to specify which system programs are to be included in the new system. A yes Y response to ITEM 27a causes SGEN to output line-by-line a list of queries, one per line, with each query comprised of a system program name and a question mark. For example:

TO BE KEPT:

F4I? \_\_\_  
EDIT? \_\_\_  
PIP? \_\_\_

.  
.  
.

Each query represents a system program currently available in the SGEN data source (i.e., Old System); the query must be answered Y if it is to be included in the new system, or no N if it is NOT to be included in the new system.

#### NOTE

The list printed in this procedure contains only the names of the system programs which are contained by the "Old System"; it does not necessarily contain a complete list of system programs as supplied on the master system tape provided by DEC. If F4I and/or MACROI have been deleted from the old system they will not be in the new system unless it is an 8K system (refer to paragraph 1.3.1.3 for details).

An N response to any of the queries frees the SYSBLK and tape storage blocks containing control information and the code for that program. If the freed areas are not used for a new program, the program "slot" in SYSBLK remains empty; however, during the actual generation of the new system onto the output device, SGEN will adjust the placement of the system programs to compensate for any contraction or expansion of the system program area required by the deletion and/or addition of programs.

The following is a list of the System Programs normally supplied on a DEC Master System:

F4I	} Special programs for 8K systems only
MACROI	
EDIT	
EDITVP	
PIP	
MACRO	
CHAIN	
F4	
DUMP	
DTCOPY	
PATCH	
UPDATE	
SRCCOM	
SGEN	



Any one or all of the above programs may be deleted from the new system during this procedure:

NOTE

The addition of a new System Program to a new system requires that a program slot be available for it in the system SYSBLK. Since the size of SYSBLK is fixed, only as many new system programs may be added as were deleted (the total is 12<sub>10</sub>). The deletion of F4I or MACROI programs does not free slots in SYSBLK since these are special programs.

3.2.14.1 ADDING F4I AND MACROI PROGRAMS TO AN 8K SYSTEM - If a new 8K system is to be generated using an Old System which does not contain MACROI or F4I files, the user must do the following:

1. Before starting the System Generation procedure the user must copy the contents of the Master DECTape onto the new system medium.<sup>1</sup>
2. The System Generation procedure as described in Section 2 must be performed. At a specific point in the procedure (ITEM 27a) the user is asked the following:

TO BE ADDED :

F4I?       
MACROI?     

A Y (yes) response to either or both of the program queries will result in the setting of pointers within the System Generator program which will reserve, for the new system, areas normally occupied by the selected program(s).

Any area reserved for F4I or MACROI within the system generator will correspond to that already occupied on the new system medium by a copied master file. During the construction of the new system, any added file (F4I or MACROI) will appear in the new system simply by being present within a reserved area. If either F4I or MACROI or both are not added, the copied files on the new system medium will be overwritten.

---

<sup>1</sup>Use of the DTCOPY utility program is recommended; refer to the Utility Manual, DEC-15-YWZA-D for a detailed description of this program.

### 3.2.15 ADD SYS PROG.?

This item represents the entry/exit point of a 3-item cycle which enables the user to name, reserve storage area, and make .DAT slot assignments for each program to be added to the new system (one cycle per program).

Once the new system has been generated onto its medium, program and handler code files may then be easily added using monitor utility programs PATCH and UPDATE.

A yes Y response to this query initiates the cycle of operations described in the next three paragraphs; a complete cycle is performed for each program added.

3.2.15.1 PROG. NAME (6 OR LESS ALPHANUMERICS). - The name of the system program to be described during the current cycle must be entered in response to this query. As indicated in the query, the name may be comprised of up to six characters which may be letters or numbers or some combination of both. The name entered must be that which is to be used in calling the program during system operations; it must not duplicate a monitor or PATCH command name as it will be added to their command tables.

3.2.15.2 # OF DEVICE BLOCKS [ ]. - The size of the named system program must be specified as the number (in octal) of 400<sub>8</sub>-word blocks which its code will require on the new system medium. The specified area will be reserved on the new system for the installation of the named program.

#### NOTE

In specifying the size of a System Program, the user must take into consideration the potential size of the Bank Bit Initialization Routines which are added to the program file during installation. Normally, these routines will not be larger than 400<sub>8</sub> words, the size of one storage block.

3.2.15.3 .DAT SLOTS (-15 TO 10 OR ALL):. - The .DAT slots to be assigned to the named program must be entered, one per line, in response to this query. .DAT slots -2 and -3 need not be mentioned in this operation; the use of .DAT slot -7 is illegal. The response "ALL" will cause the system loader to load all handlers in the positive .DAT slots when loading the program.

The .DAT slot list may be terminated when desired by entering a "DONE" terminator.

#### NOTE

This is the last operation of an ADD cycle; the user is returned to ITEM 27a on completion of the .DAT slot list where the cycle is restarted or an exit is made to ITEM 28.

#### 3.2.16 E. DISPLAY PROG ORDER

The user may obtain an ordered listing of the system programs as they will appear in the new system being generated by entering a Y response to this query.

If the user intends to optimize the loading of system programs by re-ordering their placement within the system, it is advisable that a printout of the current order be obtained at this time.

#### 3.2.17 DELETE RELOCATABLE FILES?

A yes Y response to this query initiates a procedure which enables the user to select the relocatable files which he wishes to be included in the new system being developed. The procedure is carried out in the same manner as for the System Program's keep/drop procedure (ITEM 27a); the user is queried filename by filename as to which files are to be kept. Those files to which the response is no N are not included in the new system. The following files cannot be deleted from the system:

DDT BIN  
.LOAD BIN  
EXECUT BIN  
RELNON BIN  
RELEAE BIN  
INTNON BIN  
INTEAE BIN  
.LIBR BIN

#### 3.2.18 CHANGE PROG. ORDER?

An important factor in the optimal loading of system programs from DECTape with regard to time is the order in which the programs are recorded onto the system DECTape.

The re-ordering of system programs during SGEN is permitted by this procedure. The more frequently used system programs should be placed at the beginning of the system program storage area to obtain the shortest loading times.

The use of the ALTMODE command in the re-ordering operation is discussed in 3.2.10.1.

A discussion of optimization of system program loading is given in paragraph 3.3.

### 3.3 OPTIMAL LOADING OF SYSTEM PROGRAMS

The SGEN program permits the user to order the system programs of a new system as he desires - a feature which is important in optimizing system program load time.

The time required to load a system program from the system medium, particularly DECTape, can be significantly affected by the position of the program within the system.

A diagram of the allocation of a typical 8K system on a DECTape is given in Figure 3-1.

Referencing Figure 3-1, programs CREFI<sup>1</sup>, MACROI, and F4I are present only in 8K systems; in larger systems these programs are overlaid by the ↑Q area, if it is kept, or their areas are freed. Areas freed by the deletion of system programs or by the deletion of the ↑Q area are opened for use by relocatable programs.

As shown in Figure 3-1, the tape area occupied by system programs is located at the end of the system area. The system program area is automatically expanded or contracted by SGEN to accommodate the addition or deletion of system programs.

The overall area occupied by the system can be reduced by the re-specification of the system maximum block number; this is permitted by SGEN and results in the movement of the system program area closer to the front of the tape. Shortening the overall system length in this manner reduces the area available for relocatable files; however, this may be compensated

---

<sup>1</sup>NOTE: CREFI is a 4-block area which is reserved for a cross-reference option in MACROI.

for by the deletion of unused relocatable files and the deletion of the ↑Q area. Normally, loading the monitor and a system program is accomplished in the following manner: the monitor is read into core from the top of the system tape by the bootstrap; the monitor, in turn, uses the bootstrap to load the SKPBLK and IOBLK areas.

The monitor and the skip and I/O areas are located on the system tape in a sequential order and are spaced to permit their being read in a single continuous forward movement of the system tape.

When the monitor receives a load system program ( SYS program) command, it reads into core the system loader (.SYSLD) using the bootstrap loader. The .SYSLD loader then reads, selectively, the required system program handlers from the system library (.LIBR BIN). When the handlers are loaded into core, the bootstrap is then set up to load the requested system program. The placement on the system tape of .SYSLD with respect to .LIBR BIN and the organization of the handlers within the library permits the needed handlers to be read in a continuous forward movement of the system tape. The forward movement of the tape is continued through the tape System Program area during which the requested system program is read into core. The first .SYS program in the system program area is the first reached during the read operation; therefore, it will have the shortest possible load time. As illustrated in the above description, the contents of the system tape are organized to implement an efficient loading scheme. Loading efficiency for an individual system, however, can be further enhanced by:

1. Shortening the system physical length by deleting unwanted relocatable files and the ↑Q area and specifying a smaller maximum system block;
2. Re-ordering system programs to put the most used programs at the top of the tape system program area.

- NOTES: 1)  indicates areas reserved for relocatable files.  
 2) All numbers are given in octal.

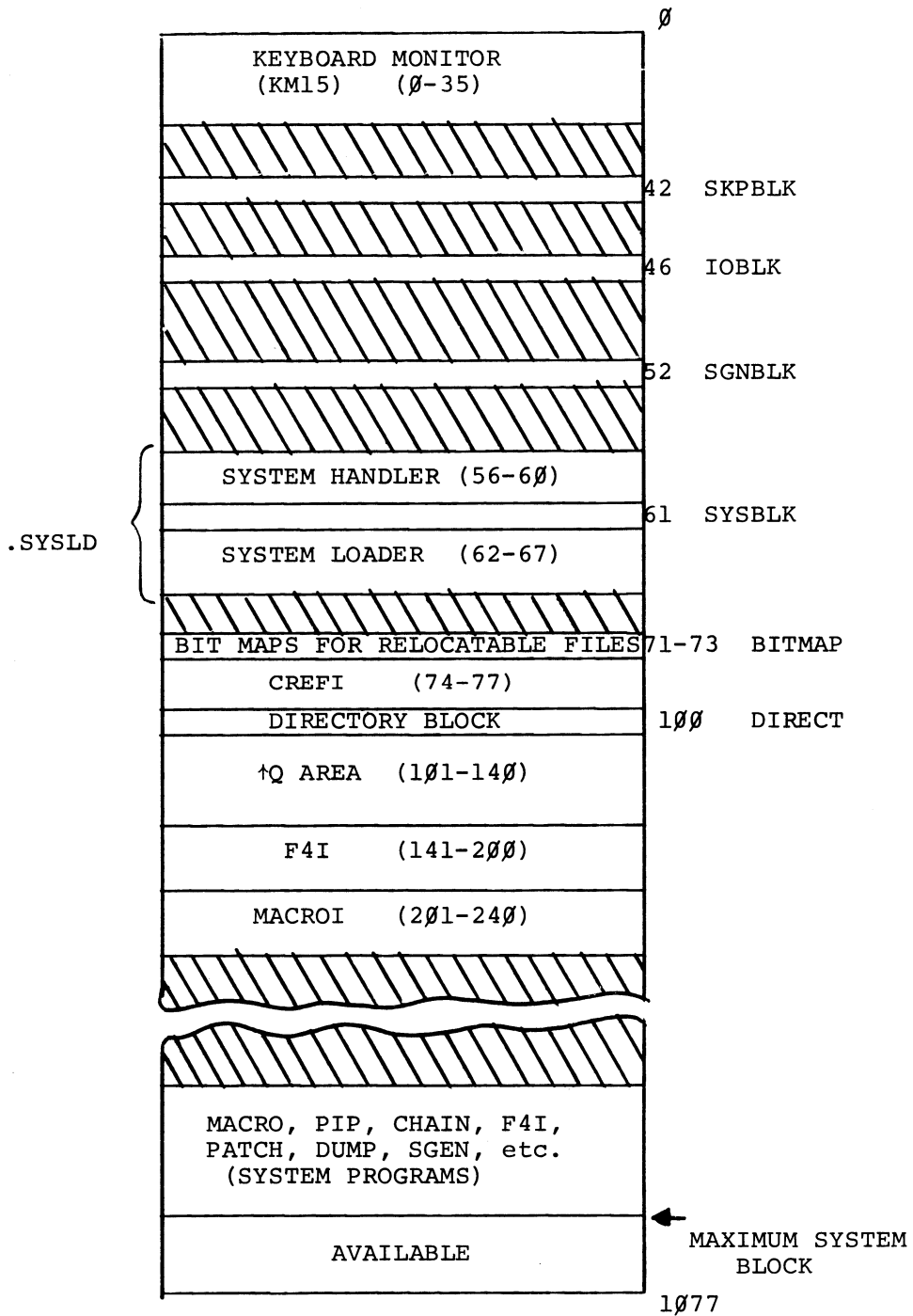

Figure 3-1. 8K System Tape Allocations

APPENDIX A

SGEN ERROR MESSAGES

The error messages which may be output by SGEN during its operations are described in the following table.

Table A-1 SGEN Error Messages

<u>Printout</u>	<u>Meaning</u>
GENERAL PURPOSE ERROR PRINTOUTS	
?	
(query repeated)	The preceding query response was not intelligible; this indicator (?) is normally followed by a reprint of the query incorrectly responded to.
SYM ONLY	
(query repeated)	The preceding entry contained or was comprised of a numeric where a symbol was required.
X	
	The preceding entry was faulty and has been ignored by SGEN; normally this indication follows a text error message. For example:
	BAD DEVICE CODE X>
"Y"/"N"	
(query repeated)	The preceding response should have been either a yes ( <u>Y</u> ) or a no ( <u>N</u> ) and was incorrectly made.
OCTAL #	
(query repeated)	An octal number was expected as the preceding response and was not received.
TOO LONG	
(query repeated)	One of the preceding entry symbols was too long; it exceeded nine characters.

SGEN OPERATIONAL ERROR MESSAGES

Printout

Meaning

SGNBLK WILL NOT FIT IN BUFFER

ABORT

This error message is output and operations are aborted if the core buffer available for the SGEN program unit is too small. This error occurs if incorrect device handler assignments are made.

.DAT SLOT -14 NOT VALID DEVICE

ABORT

\$

Terminal error, this error occurs if the device assigned to .DAT slot -14 is not a file-structured mass storage device.

.DAT SLOT -15 NOT A VALID DEVICE

ABORT

\$

Terminal error, this error occurs if the device assigned to .DAT slot -15 is not a file-structured mass storage device.

.DAT -14 AND .DAT -15 ARE SAME

NEW SYSTEM?

This message is printed if the same device has been assigned to both .DAT slots -14 and -15 and it has been indicated to SGEN that a new system is to be developed. The query NEW SYSTEM? should be answered N if a new system is not to be made or ^C should be used to reload the monitor.

.DAT-15 IS NOT THE SAME AS .DAT-14

DO YOU WISH TO PUT .DAT-14 INTO .DAT-15?

This message is printed if the modification of an old system has been indicated to SGEN and .DAT slots -14 and -15 are not assigned to the same device.

If the SGEN operation is to be the modification of an old system, the message query should be answered yes (Y).

If a new system is to be developed, answer the message query no (N) and SGEN will output:

NEW SYSTEM?

which should be answered Y.

BAD DEV CODE

X>

If the user enters a new device handler mnemonic and the first two letters of the entry are not the same as the device mnemonic, this message will be output and SGEN indicates that the last entry was ignored. A new corrected entry should then be made after the message go-ahead symbol.



3CHAR X>	Device handler mnemonics entered by the user should be 3 characters in length; no more, no less. Enter the correct mnemonic after the message go-ahead symbol.
NOT NEW X>	This message is output if the last character of the last-entered handler mnemonic is an octal number rather than a letter or if the entered mnemonic duplicated a previously entered mnemonic. The correct mnemonic should be entered after the message go-ahead symbol.
OLD DEV X>	The device code entered on the previous line is found by SGEN to be the same as that of an existing device. Enter a new code after the message go-ahead symbol.
OLD SKIP X>	The last entered skip mnemonic or IOT number is a duplicate of an existing mnemonic or number.
NOT IOT X>	The number of the last entered skip IOT is not recognized by the system; the error should be corrected and the entry retyped.
SGNBLK TOO BIG	If the entry of new devices to be added to the system device table to exceed one block in size (400 <sub>8</sub> words) this message will be output. This error should never occur in normal use.
TOO MANY SKIPS ABORT	The entry of more than 40 <sub>10</sub> skips will cause this terminal error.
BAD HANDLER EX:	This error message and example are output if an illegal handler name is entered in an A statement during the alteration of .DAT slots.
A DTA2 -4/DT1 -5,-6/DT -1	
BAD UNIT # EX:	The use of an illegal unit number (not present) in an A statement during the alteration of .DAT slots causes this error message and example to be output.
A DTA2 -4/DT1 -5,-6/DT -1	
BAD .DAT SLOT EX:	The use of an illegal .DAT slot number in an A statement during the alteration of .DAT slots causes this message and example to be output.
A DTA2 -4/DT1 -5,-6/DT -1	
NO ROOM ABORT	If there is not enough room in core to permit the loading of the .SGEN2 program unit this message is output. This error usually occurs if the wrong (too large) system device handlers have been assigned.

NOT UNIQUE	In adding system programs to the new system, the last entered name duplicated one previously entered.
TOO MANY SYSTEM PROG.	This message is output if the user attempts to enter more than 12 <sub>10</sub> system programs in the new system (excluding F4I and MACROI).
SYSBLK OVFL0 ABORT	This terminal error occurs if the .DAT slot entries for added system programs exceed the area allocated for .DAT slots in the SYSBLK.
SYSTEM TAPE TOO FULL ABORT	On the completion of the Deletion of Relocatable Files operation SGEN automatically determines if the new system output medium can actually contain the system as defined by the user. If the system is found to be too large this terminal error occurs.
↑P ILLEGAL ABORT	A ↑P input has been made after SGEN had stated that such an input would be illegal. This is a terminal error.
NEW SYSTEM DEVICE MALFUNCTION	This message is output and control is returned to the Monitor if SGEN cannot successfully copy the new system SYSfiles onto the new system medium.
.LIBR BIN MISSING ABORT	If, on the old system, the .LIBR file is found to be missing, SGEN will output this error message and will abort operations.
[Filename] MISSING	If a permanent file is found to be missing, SGEN will output the name of the file and the word MISSING but does not abort. The missing file should be PIP'd onto the old system before the system generation process.
REL[version] MISSING ABORT or	If the system which the user is generating requires a different version of the REAL or INTEGER OTS routines than is available in the old system, the appropriate message is output and the operation is aborted. For example:
INT[version] MISSING ABORT	
	RELNON MISSING ABORT
	is output and the operation aborted if the non-EAE version of the REAL routine is not on the old system and is required by the new system.

<p>INTEAE OR INTNON NOT IN ABORT</p>	<p>.LIBR BIN SGEN was unable to find any version of the OTS integer routine in the library (old system).</p>
<p>RELEAE OR RELNON NOT IN ABORT</p>	<p>.LIBR BIN SGEN was unable to find any version of the OTS real (REAL) routine in the library (old system).</p>
<p>5 READ ERRORS ABORT</p>	<p>If SGEN has difficulty in reading the .LIBR BIN file it will make the attempt five times then will output this message and will abort operations.</p>
<p>HANDLER XXC. MISSING ABORT</p>	<p>If SGEN searches the library and cannot find the C version of the system device handler, it will output this message and will abort operations.</p>
<p>NO ROOM ABORT</p>	<p>If SGEN cannot find room in core for the specified system handler, it will output this message and will abort operations. This error should never occur.</p>
<p>SYS HAND TOO BIG ABORT</p>	<p>If the system handler is larger than 1400 words in length, it will exceed the space available to it; SGEN then outputs this message and aborts operations.</p>



## APPENDIX B

### EXAMPLE, GENERATION OF AN OPTIMIZED 8K DECTAPE SYSTEM

The following example represents the Teletype printout obtained during the system generation, onto DECTape, of a 15/20 DECTape system. The new system is being developed from the master DECTape supplied by Digital and is being optimized for an 8K "DECTape only" system application. Only small modifications to the procedure illustrated in this example need be made to develop systems larger than 8K.

In the example, the new system to be developed has been optimized by:

1. shortening the library (.LIBR BIN) by the deletion of all unused DECdisk handlers;
2. reducing the size of the resident monitor by eliminating the skips for DECdisk, magnetic tape, line printer, card reader, and VP display; since this is to be a DECTape only system.
3. for user convenience, 8TRAN has been allotted an area in the new system as a SYS file and is deleted as a relocatable file. The 8TRAN program will be patched into the new system after SGEN as SYS file 8TRN;
4. system program EDITVP is deleted since no VP display is included in the system;
5. A  $\uparrow$ Q area is not included in the new system in order to save space;
6. program loading is optimized by the specification of a shorter system length through the entry of a maximum system block number of 677<sub>8</sub>. Re-specification of the maximum system block # takes advantage of the deleted  $\uparrow$ Q area and all other freed areas to move the SYS files nearer the directory.

KM15 V5A

\$A DTØ -14/DT1 -15

\$SGEN

SGEN V4A

NEW SYSTEM? Y

SYSTEM DEVICE[DT]

NEW SYSTEM ON DT1 FROM OLD SYSTEM ON DTØ

CORE SIZE (8, 12, 16, 2Ø, 24, 28, OR 32) [8]

↑Q AREA? (N) N

EAE? (Y) N

DELETE DISCARDED HANDLERS FROM .LIBR? Y

MAX. SYSTEM BLOCK #[1Ø77] 677

API? (N) N

33 TTY? (N) N

A. ALTER I/O DEVICES OR HANDLER? Y

TO BE KEPT:

PR? Y

PRA? Y

PRB? Y

>

RSF=7ØØ1Ø1

PP? Y

PPA? Y

PPB? Y

PPC? Y

>

PSF=7ØØ2Ø1

DT IS SYSTEM DEVICE AND DTC IS SYS HAND

DTA? Y

DTB? Y

DTD? Y

DTE? Y

DTF? Y

>

DTDF=707601

DTEF=707561

DK? N

MT? N

LP. N

CD? N

VP? N

ADD NEW DEVICE? N

B. DISPLAY SKIP CHAIN? Y

SPFAL

DTDF

CLSF

RSF

PSF

KSF

TSF

DTEF

MPSNE

MPSK

SPE

CHANGE SKIP CHAIN ORDER? N

C. DISPLAY .DAT SLOTS? Y

-15 DTA2

-14 DTA1

-13 PPC0

-12 TTA0

-11 PRB0

-10 TTA0

-6 DTB2

-5 NONE

-4 DTC2

-1 DTC0

1 DTA0

2 DTA1

3 DTA2

4 TTA0

5 PRA0

6 PPA0

7 DTA1

10 DTA2

ALTER .DAT SLOTS:

>

D. CHANGE SYS PROG.? Y

TO BE KEPT"

DTCOPY? Y

SRCCOM? Y

F4I? Y

EDIT? Y

MACRO. Y

PIP? Y

F4? Y

SGEN? Y

DUMP? Y

UPDATE? Y

EDITVP? N

MACROI? Y

CHAIN? Y

PATCH? Y

ADD SYS PROG.? Y

PROG. NAME (6 OR LESS ALPHAMERIC) 8TRN

# OF DEVICE BLOCKS[] 11

.DAT SLOTS(-15 TO 1Ø OR ALL):

>-15

>-14

>

ADD SYS PROG.? N

E. DISPLAY PROG. ORDER? Y

EDIT

PIP

MACRO

CHAIN

F4

DUMP

DTCOPY

PATCH

UPDATE

SRCCOM

SGEN

8TRN



DELETE RELOCATABLE FILES? Y

TO BE KEPT:

FOCAL BIN? Y  
8TRAN BIN? N  
FNEW SRC? N  
TIME BIN? N  
TIME1Ø BIN? N  
FOCAL XCU? Y  
FOCAL XCT? Y

CHANGE PROG ORDER? Y

RETYPE PROG. NAMES IN SESIRED ORDER  
(\$ CAUSES FIRST UNUSED PROG. FROM  
OLD ORDER TO BE ADDED AT THAT POINT):

>\$EDIT  
>\$PIP  
>\$MACRO  
>\$CHAIN  
>\$F4  
>\$DUMP  
>\$DTCOPY  
>\$PATCH  
>\$UPDATE  
>\$SRCCOM  
>8TRN  
>\$SGEN

SGEN IN PROGRESS ( 1P ILLEGAL)

DELETED HANDLERS:

RFC.  
RFA.  
RFB.  
RFD.  
RFE.  
RFF.

SGEN COMPLETE

DIRECTORY LISTING

13 FREE BLKS

13 USER FILES

627 SYSTEM BLKS

.LOAD	BIN	36	10
DDT	BIN	37	13
EXECUT	BIN	40	3
INTEAE	BIN	41	1
INTNON	BIN	47	1
RELEAE	BIN	54	4
RELNON	BIN	104	4
.LIBR	BIN	105	123
FOCAL	BIN	122	23
FOCAL	XCU	244	27
FOCAL	XCT	363	1
KM15	SYS	0	
SKPBLK	SYS	42	
IOBLK	SYS	46	
SGNBLK	SYS	52	
SYSHAN	SYS	56	
SYSBLK	SYS	61	
.SYSLD	SYS	62	
BITMAP	SYS	71	
DIRECT	SYS	100	
F4I	SYS	141	
MACROI	SYS	201	
EDIT	SYS	434	
PIP	SYS	446	
MACRO	SYS	466	
CHAIN	SYS	524	
F4	SYS	544	
DUMP	SYS	576	
DTCOPY	SYS	602	
PATCH	SYS	605	
UPDATE	SYS	614	
SRCCOM	SYS	624	
8TRN	SYS	636	
SGEN	SYS	647	

## HOW TO OBTAIN SOFTWARE INFORMATION

Announcements for new and revised software, as well as programming notes, software problems, and documentation corrections are published by Software Information Service in the following newsletters.

Digital Software News for the PDP-8 & PDP-12  
Digital Software News for the PDP-11  
Digital Software News for the PDP-9/15 Family

These newsletters contain information applicable to software available from Digital's Program Library. Articles in Digital Software News update the cumulative Software Performance Summary which is contained in each basic kit of system software for new computers. To assure that the monthly Digital Software News is sent to the appropriate software contact at your installation, please check with the Software Specialist or Sales Engineer at your nearest Digital office.

Questions or problems concerning Digital's Software should be reported to the Software Specialist. In cases where no Software Specialist is available, please send a Software Performance Report form with details of the problem to:

Software Information Service  
Digital Equipment Corporation  
146 Main Street, Bldg. 3-5  
Maynard, Massachusetts 01754

These forms which are provided in the software kit should be fully filled out and accompanied by teletype output as well as listings or tapes of the user program to facilitate a complete investigation. An answer will be sent to the individual and appropriate topics of general interest will be printed in the newsletter.

Orders for new and revised software and manuals, additional Software Performance Report forms, and software price lists should be directed to the nearest Digital Field office or representative. U.S.A. customers may order directly from the Program Library in Maynard. When ordering, include the code number and a brief description of the software requested.

Digital Equipment Computer Users Society (DECUS) maintains a user library and publishes a catalog of programs as well as the DECUSCOPE magazine for its members and non-members who request it. For further information please write to:

DECUS  
Digital Equipment Corporation  
146 Main Street, Bldg. 3-5  
Maynard, Massachusetts 01754



READER'S COMMENTS

Digital Equipment Corporation maintains a continuous effort to improve the quality and usefulness of its publications. To do this effectively we need user feedback -- your critical evaluation of this manual.

Please comment on this manual's completeness, accuracy, organization, usability and readability.

---

---

---

---

Did you find errors in this manual? If so, specify by page.

---

---

---

---

How can this manual be improved?

---

---

---

---

Other comments?

---

---

---

---

Please state your position. \_\_\_\_\_ Date: \_\_\_\_\_

Name: \_\_\_\_\_ Organization: \_\_\_\_\_

Street: \_\_\_\_\_ Department: \_\_\_\_\_

City: \_\_\_\_\_ State: \_\_\_\_\_ Zip or Country \_\_\_\_\_

