

**Canon**  
COMPUTER SYSTEMS 

*You need new tools for today's challenges.*

16-bit microcomputer  
**AS-100**

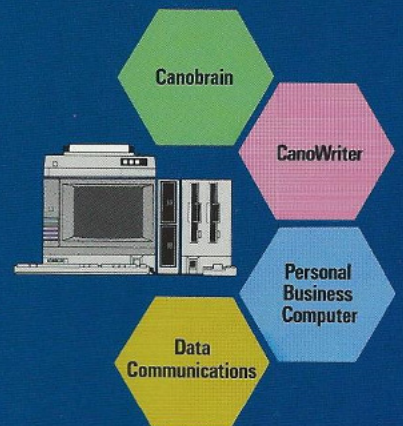

# *You need new tools for today's challenges.*

*Everyone's using microcomputers—because they're convenient tools to help extend one's capabilities. With the fast pace of today's business world, you can't afford to miss a step, or delay a minute.*

*Although they were originally used for problem-solving, microcomputers are now principally a tool for organizing information. They take raw data and organize it in a form which allows decision-making to be easier and more efficient.*

*Most managers say the most important part of their job is making decisions. Decisions about new products. About budgets. About personnel. About any and every part of their companies.*

*So the role of microcomputers in today's office must go beyond productivity improvement to actual decision support—extending their users' capabilities.*





**The tool for decision-makers.**

Canon's AS-100 is the intelligent business work station which will help you make faster, better-informed decisions. The key is our CANOBRAIN family of business programs.

CANOBRAIN makes the AS-100 come alive with power. It includes the Canobrain package with CanoCalc, CanoGraph, and CanoFile. Plus the versatile CanoWriter word processing program. The CANOBRAIN family is versatile enough to support your creative thought processes and decision-making—in any task.

The AS-100 puts computing power where you need it most—helping you develop new ideas and strategies, giving you the information and perspective you need for better decisions.

**The AS-100 isn't just one microcomputer. It's four.**

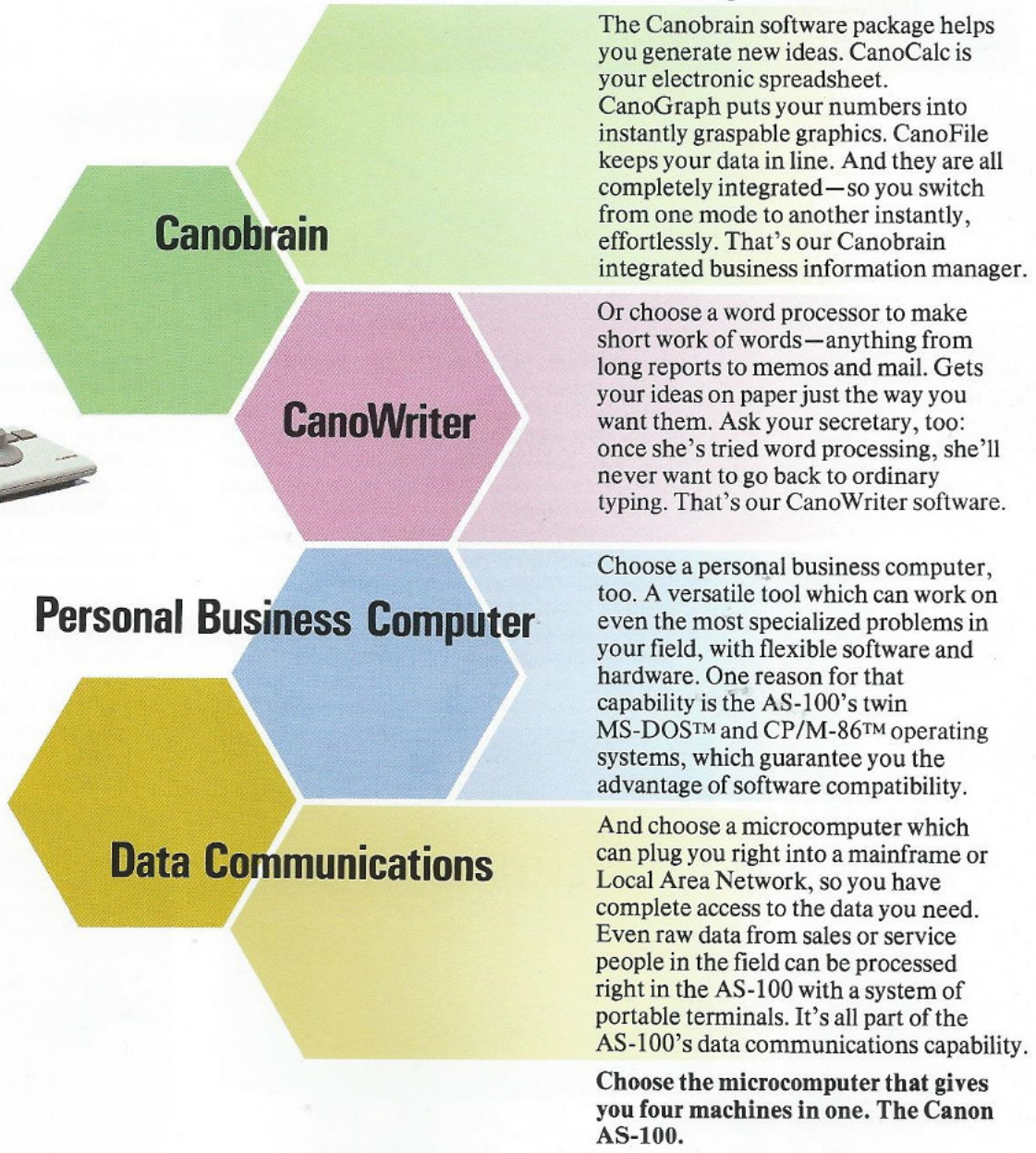

**Canobrain is your idea generator.**

The ideal executive assistant prepares information and organizes it so you can reach a meaningful conclusion. So does Canobrain.

Canobrain is an integrated business information manager, including an electronic spreadsheet (CanoCalc), business graphics (CanoGraph), and a data base manager (CanoFile). You can switch from one mode to another instantly because all three programs

are completely integrated. Less work and more power!

CanoCalc is designed to do business simulations: try changing a number in one of your spreadsheets. CanoCalc recalculates all the relevant totals automatically. You see instantly what effect your change will have.

Then CanoGraph puts your tabular data into a wide variety of graphs so the trends are apparent at a glance. They can even be in brilliant color.

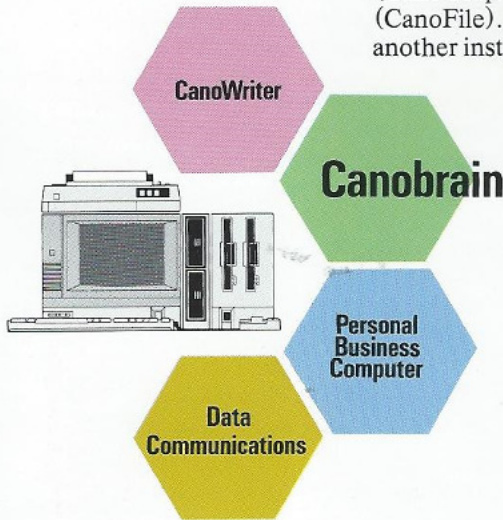

**The tool for decision-makers.**

**TOTAL PATTERN**

Pre-select data entry order with the If your regular work follows a set command the computer to remember parameters every time—just let Canobrain

**ROLL**

**TABLE**

**CanoFile**

**Tremendous data base capacity, tremendous versatility in CanoFile.**

Under Canobrain's data file system, you can store up to 10,000 rows of data in one roll. That means you can take data from a mainframe and use it under Canobrain. Or use your CanoFile roll as the raw data for an outside program.

- Up to 9,999 rows of data, each 99 columns long, each column up to 74 characters.
- Reads and writes on standard IBM-format floppy disks.
- Format data as you prefer for reports. Printout is possible with subtotals available during data retrieval.

**Advanced search and retrieval functions, flexible data handling in CanoFile and CanoCalc.**

Search your roll or table data for the items you need, then copy them to another roll, table, or even to the printer. Rearrange your data in ascending or descending order, using up to five key fields. CanoCalc recalculates derived cells automatically when you enter new data or change an entry.

- Search commands include >, ≥, <, ≤, =, ≠, BT (Between), NB (Not Between), \* (And), + (Or).
- Data entry is as easy and worry-free as positioning the cursor on the screen and pushing the keys. Corrections are equally simple.
- For faster data entry, CanoCalc features a pattern input mask so you choose what order the data goes in. The automatic data generation function is handy for predictable progressions. And the data duplication function lets you recreate cells wherever necessary.
- Table format editing is easy—add, delete, move columns or rows anytime. A double check question safeguards your data against accidental erase commands.
- No need to insert commas every three digits, nor dollar signs or other repetitive symbols. The following are automatically inserted upon command: 0, +, -, \*, \$, and blanks.

GROSS PROFIT BY PRODUCT		DATE 83.09.20						PAGE 1
ITEM NAME	BRANCH	Jan-9-p.	Feb-9-p.	Mar-9-p.	Apr-9-p.	May-9-p.	Jun-9-p.	total-9-p.
BLENDER	EAST	\$1,520	\$1,460	\$1,600	\$1,680	\$1,560	\$1,680	\$9,440
BLENDER	WEST	\$1,400	\$1,120	\$1,280	\$1,320	\$1,320	\$1,480	\$7,920
BLENDER	NORTH	\$1,060	\$1,000	\$1,160	\$1,200	\$1,100	\$1,160	\$6,620
BLENDER	SOUTH	\$340	\$480	\$720	\$720	\$600	\$720	\$3,780
BLENDER	CENTRAL	\$1,400	\$1,300	\$1,440	\$1,400	\$1,400	\$1,460	\$8,400
		\$5,920	\$5,360	\$6,200	\$6,320	\$5,960	\$6,440	\$36,160
DRYER	EAST	\$14,400	\$18,000	\$18,000	\$12,600	\$18,000	\$18,000	\$99,000
DRYER	WEST	\$10,800	\$10,800	\$10,800	\$11,700	\$10,800	\$12,600	\$67,500
DRYER	NORTH	\$22,500	\$18,000	\$22,500	\$27,000	\$27,000	\$30,000	\$147,000
DRYER	SOUTH	\$6,000	\$5,600	\$6,600	\$10,000	\$7,000	\$8,000	\$43,200
DRYER	CENTRAL	\$30,080	\$30,000	\$33,000	\$33,000	\$33,800	\$37,500	\$196,500
		\$83,780	\$82,400	\$90,900	\$94,300	\$95,600	\$106,100	\$553,200
FLOOR LAMP	EAST	\$5,200	\$5,500	\$5,500	\$5,750	\$6,250	\$6,250	\$34,750
FLOOR LAMP	WEST	\$5,000	\$5,000	\$5,000	\$5,000	\$5,000	\$5,000	\$30,000
FLOOR LAMP	NORTH	\$5,000	\$8,000	\$8,600	\$9,600	\$10,000	\$10,000	\$55,200
FLOOR LAMP	SOUTH	\$1,755	\$1,755	\$1,890	\$1,620	\$1,755	\$1,755	\$10,530
FLOOR LAMP	CENTRAL	\$5,800	\$10,000	\$10,200	\$10,400	\$10,600	\$10,800	\$60,400
		\$31,055	\$30,255	\$31,190	\$32,370	\$33,005	\$33,005	\$190,880
FOOD PROCESSOR	EAST	\$6,000	\$6,000	\$7,000	\$6,000	\$6,400	\$6,000	\$37,400
FOOD PROCESSOR	WEST	\$6,000	\$6,000	\$5,800	\$5,800	\$5,600	\$5,600	\$34,800
FOOD PROCESSOR	NORTH	\$7,050	\$6,300	\$7,500	\$7,800	\$7,800	\$7,800	\$44,250
FOOD PROCESSOR	SOUTH	\$1,610	\$1,380	\$1,610	\$1,725	\$1,265	\$1,610	\$9,200
FOOD PROCESSOR	CENTRAL	\$7,500	\$7,500	\$8,250	\$8,100	\$8,400	\$8,250	\$48,000
		\$28,160	\$27,180	\$30,160	\$29,425	\$29,465	\$29,260	\$172,650
HEATER	EAST	\$9,600	\$8,000	\$5,600	\$4,800	\$4,000	\$4,000	\$36,800
HEATER	WEST	\$8,000	\$9,600	\$6,400	\$5,600	\$4,000	\$4,000	\$37,600
HEATER	NORTH	\$9,000	\$12,000	\$9,000	\$7,200	\$4,800	\$3,600	\$45,600
HEATER	SOUTH	\$5,000	\$7,000	\$4,000	\$3,000	\$2,000	\$2,000	\$23,000
HEATER	CENTRAL	\$12,000	\$15,000	\$13,200	\$9,600	\$7,200	\$6,000	\$63,000
		\$43,600	\$51,600	\$38,200	\$30,200	\$22,000	\$20,400	\$206,000
MIXER	EAST	\$5,250	\$4,950	\$5,700	\$5,700	\$5,250	\$5,700	\$32,550
MIXER	WEST	\$4,800	\$4,200	\$5,250	\$4,100	\$4,800	\$4,950	\$28,500
MIXER	NORTH	\$6,240	\$5,850	\$7,150	\$7,150	\$6,760	\$6,760	\$39,910
MIXER	SOUTH	\$1,400	\$1,300	\$1,400	\$1,600	\$1,200	\$1,600	\$8,500
MIXER	CENTRAL	\$7,540	\$7,150	\$7,540	\$7,540	\$7,670	\$7,670	\$45,110
		\$22,230	\$22,450	\$27,040	\$26,490	\$25,680	\$26,680	\$154,570
		\$217,665	\$220,185	\$223,690	\$219,105	\$211,930	\$221,885	\$1,314,460

And Canobrain tells you just how to do all that in ordinary, conversational operation. Operations are handled with a simple flick of special function keys. Even a person with no computer experience at all can make charts and graphs in minutes using CanoGraph.

That's the kind of performance which helps you to generate better ideas and make better decisions.



**Total Pattern function.** pattern, Canobrain lets you it. No need to set up data entry take over while you enter the data.

## BOOK

## GRAPH

### CanoCalc

Make up tables fast with data direct from CanoFile; use them for outside programs, too. Because Canobrain is completely integrated, you can take the data you want right from the master roll and format it in any kind of table. And tables can be used as Common Data (CD) files with outside programs written in BASIC, COBOL, or other languages.

- Tables can be up to 255 rows long, with 99 columns of 75 characters each.
- You can have CanoCalc automatically calculate any derived cell in a table.
- Simulation is possible without destroying original data. CanoCalc tables are held in main memory during data entry and other operations—they are not written to disk except when you specify.
- Transfer items from your CanoFile right to CanoCalc without changing disks or programs.

### CanoGraph

Automatic graphic simulation based on tabular data.

Canobrain's totally integrated book system means that any change in a table is automatically reflected when you display the data graphically.

- Choose any of eight graph styles—CanoGraph creates it automatically. Charts include pics, composition ratios, lines, stacked bars, comparative bars, stacked bars and lines, comparative bars and lines, and scatter diagrams.
- Wide selection of colors and patterns for every kind of graph. Choices include: scale, grid, color, hatching, lines, symbols, axes, legends, and input comments.
- Print your graphs with one touch of the keyboard.

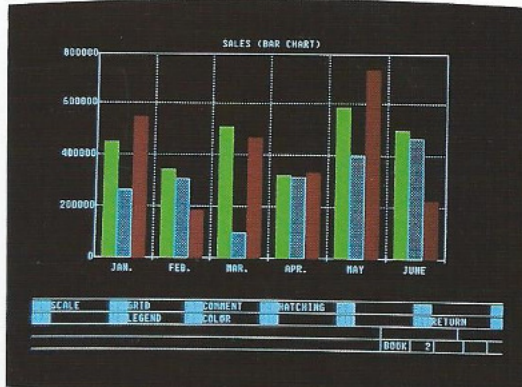

CITY	JAN.	FEB.	MAR.	APR.	MAY
NEW YORK	444,000	344,500	509,000	522,000	536,000
TOKYO	26,800	30,500	98,000	316,200	538,000
LONDON	54,700	136,400	46,700	332,900	737,000
MOSCOW	130,000	177,800	291,200	127,700	432,200
SHANGHAI	26,800	118,000	138,500	35,500	184,200
PARIS	201,600	350,800	615,500	124,500	537,000
ESSEX	164,200	206,500	439,800	193,700	352,400
FRANKFURT	211,500	376,500	330,000	202,700	276,700
LVS. ANGELES	230,000	426,000	271,500	33,500	243,000
CHICAGO	243,000	327,500	128,000	298,000	217,500
CALCUTTA	164,700	213,500	156,000	509,000	387,500
MEXICO CITY	281,600	35,000	466,200	205,000	294,600
DETROIT	26,800	26,500	19,800	46,600	847,500
BOMBAY	33,900	37,000	44,100	134,400	361,000
RIO DE JANEIRO	261,600	228,000	198,000	147,800	227,600
PHILADELPHIA	256,600	215,800	342,000	282,200	215,800
PEKING	256,600	138,900	190,800	276,800	438,200
HONG KONG	183,100	119,100	248,200	165,000	334,500
AMSTERDAM	293,000	326,500	324,000	13,000	13,000

# Here's how your Canobrain idea-generator works

## Imagine the situation...

You're the marketing manager at a major manufacturer of electric appliances. In your territory are five regional distributors from whom you receive quarterly sales forecasts. You need these figures to plan production and order volume to meet your sales target. Recently, market competition has intensified and you are looking for a way to strengthen your strategic position.

With Canobrain, your analysis is easier than ever—and so your answers come faster, too. Just pull in the raw data from your data base CanoFile, create summary tables with CanoCalc, and then proceed to graphics with CanoGraph. You can make simulations necessary to find the solution.

**Step 1** Your assistant inputs the names, cost, sales price, and monthly forecast by product for all regions into CanoFile. Monthly sales and gross profit will be automatically calculated by CanoFile using the formula you select.

## Tighten sales administration and maintain market share.

Market share is one of the keys to success—so it's essential to get a good grip on each distributor's local market share in each product category. That requires a closer watch on each distributor's sales administration: cost, price, and monthly sales for each product.

**Step 2** Have your assistant make a table of each region's forecast using model-by-model quantity, forecast sales, and gross profit figures drawn from CanoFile. Next is a monthly sales trend graph for key models, based on the table you just made. It will help you spot trends and heavy or light sales months at a glance.

## Next, set a strategy based on results.

Here's where the manager's work really begins. Using the tables and data prepared for you in Steps 1 and 2, you can pick out the trends and decide your strategy to win.

**Step 3** COPY the regional totals and gross profit calculated in Step 2 into a single table. This gives you a picture of your overall achievement.

Make up graphs from this table. For example, you can see each region's share of overall sales for a half year in one glance. Or you can see which region has the highest sales and gross profit.

**Step 4** Then play with new forecast figures and CanoCalc will provide you with a simulation of the total sales and total gross profit columns. It's easy to graph the results.

## Finally, analyze sales by product and set your production strategy.

As the number of products on the market rises, it becomes more difficult to keep track of sales trends. Precise figures keep your marketing and sales promotion strategies on track.

**Step 5** Using the RETRIEVE and READ FROM CanoFile functions, take each region's model-by-model forecast from the CanoFile into a CanoCalc table. You can see which territory is selling the most of any given product. You can make any graph you need from this table. For example, one compares each region's breakdown of sales by model. Another shows which regions are doing best for selected models.

## Who can use Canobrain?

It's tempting to say that any executive, manager, or professional can put Canobrain to good use. But here are a few of the most apparent uses.

In planning and research: Use Canobrain in market simulations, sales analysis, and market research questionnaire compilation.

In personnel and finance: Use Canobrain for personnel planning and management, cost and financial controls, loan and lease management, and general accounting.

In sales and line business: Use Canobrain for sales analysis (by customer, salesman, product, or branch), budgeting, and financial controls (including inventory, billing, invoices, and costs).

In field service: Use Canobrain for customer analysis, unit management, scheduling, and spare parts control (stock and payments).

MASTER ROLL (Monthly Sales & Amt't & G.P.)									
BRANCH	ITEM NAME	COST	PRICE	JAN.	jan-g.p.	jan-s.p.	FEB.	feb-s.amnt	feb-g.p.
EAST	DRYER	\$150.00	\$300.00	100	\$30000	\$18,000	100	\$30,000	\$18,000
EAST	WASHING MACHINE	\$200.00	\$400.00	120	\$48000	\$24,000	130	\$52,000	\$26,000
EAST	VACUUM CLEANER	\$80.00	\$170.00	130	\$22100	\$11,700	150	\$29,500	\$13,500
EAST	TABLE LAMP	\$20.00	\$35.00	350	\$12250	\$5,250	330	\$11,550	\$4,950
EAST	FLOOR LAMP	\$50.00	\$55.00	220	\$12100	\$5,500	220	\$12,100	\$5,500
EAST	WALL FIXTURE	\$10.00	\$20.00	280	\$5600	\$2,800	280	\$5,600	\$2,800
EAST	MIXER	\$25.00	\$40.00	350	\$14000	\$5,250	330	\$13,200	\$4,950
EAST	FOOD PROCESSOR	\$30.00	\$50.00	300	\$15000	\$6,000	300	\$15,000	\$6,000
EAST	BLENDER	\$16.00	\$20.00	200	\$4000	\$800	150	\$3,000	\$600
EAST	HEATER	\$60.00	\$140.00	120	\$16800	\$8,400	100	\$14,000	\$7,000
WEST	DRYER	\$150.00	\$300.00	50	\$15000	\$9,000	45	\$14,650	\$8,100
WEST	WASHING MACHINE	\$200.00	\$400.00	45	\$18000	\$9,000	45	\$18,000	\$9,000
WEST	VACUUM CLEANER	\$80.00	\$170.00	50	\$8500	\$4,250	45	\$7,650	\$4,050
WEST	TABLE LAMP	\$20.00	\$35.00	250	\$8750	\$3,750	250	\$8,750	\$4,375
WEST	FLOOR LAMP	\$50.00	\$55.00	230	\$11000	\$5,500	240	\$11,000	\$5,000
WEST	WALL FIXTURE	\$10.00	\$20.00	250	\$5000	\$2,500	180	\$3,600	\$1,800
WEST	MIXER	\$25.00	\$40.00	320	\$12800	\$4,800	280	\$11,200	\$4,200
WEST	FOOD PROCESSOR	\$30.00	\$50.00	300	\$15000	\$6,000	300	\$15,000	\$6,000
WEST	BLENDER	\$16.00	\$20.00	350	\$7000	\$1,400	280	\$5,600	\$1,120
WEST	HEATER	\$60.00	\$140.00	220	\$30800	\$17,800	200	\$28000	\$16,000
NORTH	DRYER	\$150.00	\$300.00	150	\$45000	\$22,500	120	\$36,000	\$18,000
NORTH	WASHING MACHINE	\$200.00	\$350.00	230	\$80500	\$41,500	200	\$70,000	\$35,000
NORTH	VACUUM CLEANER	\$80.00	\$150.00	180	\$27000	\$12,600	150	\$22,500	\$10,500
NORTH	TABLE LAMP	\$20.00	\$32.00	420	\$13440	\$5,040	400	\$12,800	\$4,800
NORTH	FLOOR LAMP	\$50.00	\$50.00	450	\$22500	\$9,000	400	\$20,000	\$8,000
NORTH	WALL FIXTURE	\$10.00	\$16.00	500	\$8000	\$3,000	450	\$7,200	\$2,700
NORTH	MIXER	\$25.00	\$38.00	480	\$18240	\$6,240	450	\$17,100	\$5,650
NORTH	FOOD PROCESSOR	\$30.00	\$45.00	380	\$14400	\$4,800	280	\$12,600	\$4,200
NORTH	BLENDER	\$16.00	\$18.00	530	\$9540	\$1,095	500	\$9,000	\$1,000
NORTH	HEATER	\$60.00	\$120.00	150	\$18000	\$9,000	200	\$24,000	\$12,000
SOUTH	DRYER	\$150.00	\$300.00	3,410	\$256800	\$107,170	3,150	\$231,200	\$97,050
SOUTH	WASHING MACHINE	\$200.00	\$400.00	1,400	\$56000	\$28,000	1,200	\$48,000	\$24,000
SOUTH	VACUUM CLEANER	\$80.00	\$170.00	1,400	\$23800	\$11,900	1,200	\$26,400	\$13,200
SOUTH	TABLE LAMP	\$20.00	\$35.00	4,200	\$14700	\$5,250	4,000	\$14,000	\$5,000
SOUTH	FLOOR LAMP	\$50.00	\$55.00	4,500	\$24750	\$9,000	4,000	\$22,000	\$8,000
SOUTH	WALL FIXTURE	\$10.00	\$16.00	5,000	\$8000	\$3,000	4,500	\$7,200	\$2,700
SOUTH	MIXER	\$25.00	\$38.00	480	\$18240	\$6,240	450	\$17,100	\$5,650
SOUTH	FOOD PROCESSOR	\$30.00	\$45.00	380	\$14400	\$4,800	280	\$12,600	\$4,200
SOUTH	BLENDER	\$16.00	\$18.00	530	\$9540	\$1,095	500	\$9,000	\$1,000
SOUTH	HEATER	\$60.00	\$120.00	150	\$18000	\$9,000	200	\$24,000	\$12,000

(NORTH) MONTHLY Q'TY TABLE - SIMULATION -

ITEM NAME	COST	PRICE	JAN.	FEB.	MAR.
DRYER	\$150.00	\$300.00	230	200	250
WASHING MACHINE	\$200.00	\$350.00	180	200	220
VACUUM CLEANER	\$80.00	\$150.00	150	120	180
TABLE LAMP	\$20.00	\$32.00	450	400	450
FLOOR LAMP	\$50.00	\$50.00	450	400	450
WALL FIXTURE	\$10.00	\$16.00	500	500	500
MIXER	\$25.00	\$38.00	480	450	500
FOOD PROCESSOR	\$30.00	\$45.00	380	280	380
BLENDER	\$16.00	\$18.00	500	400	500
HEATER	\$60.00	\$120.00	150	200	150

## Step 5

This table shows which regions are strongest in which model and again, the information is easy to graph.

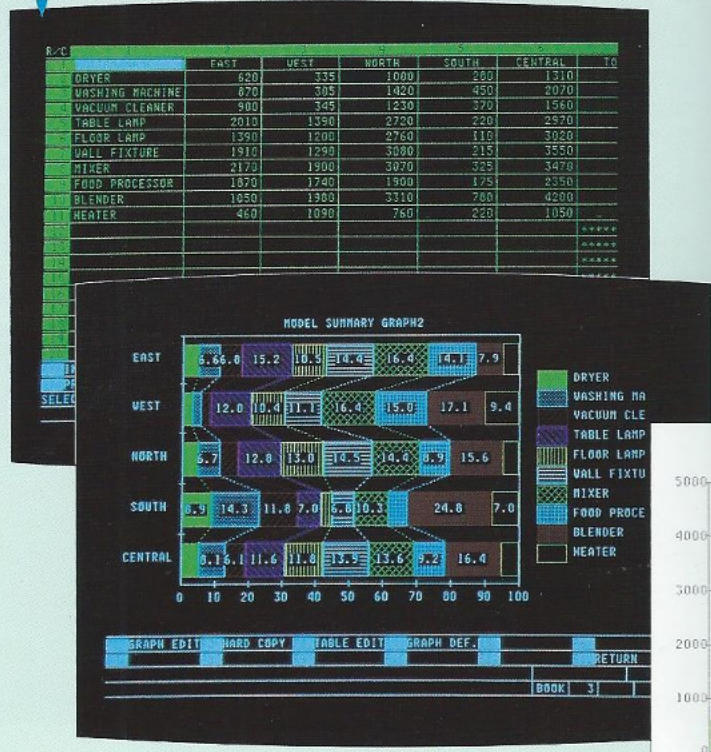



**Take the tedium out of everything from short memos to long reports.**

Think of all the written words your office generates every day. Your dictation, reports, interoffice memos, and everything else.

Now, there's an easier, more accurate way to get your thoughts on paper. With Canon's word processing system, CanoWriter.

**Say what you want to say.** Writing a report? Put your thoughts on paper the easy CanoWriter way.

Then send them to your staff for execution. Reviewing someone's work? Make your changes right in the document, so they come out the way you want them.

It's so easy and foolproof, your secretary will want a CanoWriter of her own.

**You'll never go back to ordinary typing.**

In word processing, you revise as you go. The end product is just right — without retyping.

Hate documents which are reviewed and revised frequency? Just type in the

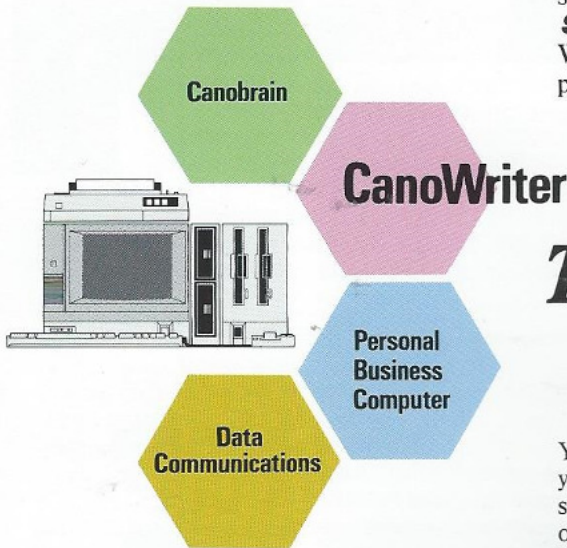

# The tool that makes short work

You'll find CanoWriter has all the power you need for easy writing. Of course, it has standard word processing features such as on-screen editing, deleting, inserting, and block moves. Of course, it has automatic search-and-replace, English hyphenation, and other convenient features.

But you'll be pleasantly surprised to see what else CanoWriter has to offer.

**On-screen print image.**

This sophisticated features means that the screen shows you exactly what will be printed out. If you've specified italic printout, the screen shows you italics. If you've asked for boldface, sub- or super-script, or any other special printout—you'll see it right on the screen.

**There's HELP at the press of a button.**

Using a word processor for the first time? Or forget how to execute an unusual function? No need to plow through pages of an instruction manual. Just ask for HELP and CanoWriter tells you what to do.

The program includes complete "help menus" for all operations. And all the instructions are in ordinary conversational

language, so even a first-time user can get the most out of the program.

An added bonus: no special training period for secretarial staff who are new to the machine. Just let them start right into work.

**Layout display for quick page formatting.**

One of the most exciting features on CanoWriter is the page layout display. At the press of a button, you can see a miniature of the entire page highlighted in a corner of the screen.

That way, you can check the page layout—is the page too empty or too full? Does a section need to be indented for effect?

If you find a place to change, simply move the cursor inside the mini-page layout to the problem spot. Then, return to regular editing. CanoWriter puts you right where your cursor was positioned on the page.

**Automatic filing for letters, memos, or other documents.**

Need to find a letter you sent out last month? Just type in any key statistic: addressee, date, word processor operator, or

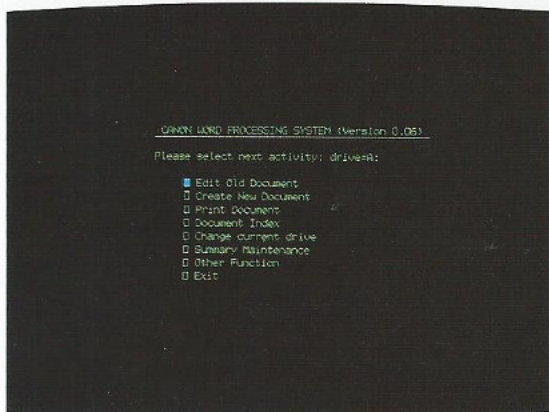

Main menu

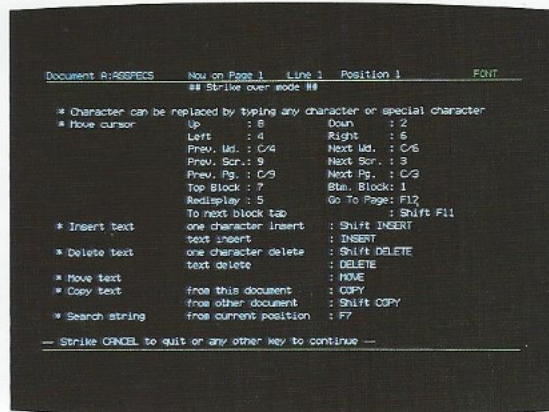

Help screen

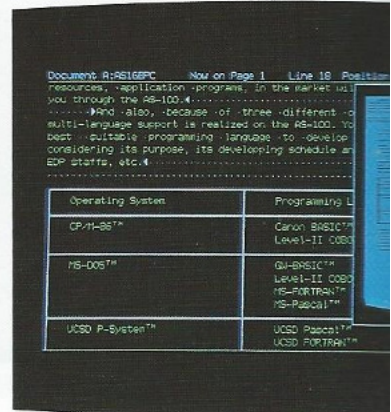

Layout display



changes and print out the completely revised document.

Word processing puts the speed and convenience of electronics to work — changing the order of sentences, paragraphs, or pages. Erasing words, lines, or blocks. Substituting individual names in form letters. And much, much more.

You'll find document creation is easier than you think. But watch out — with word processing features like this, you'll be sharing your AS-100 with your secretary soon.

# Work of words.

whatever. CanoWriter finds the document you want automatically.

### Even tables are easy with decimal tabs.

CanoWriter has a convenient decimal tab function so numbers are easy to line up. And the screen lays out your table with perfectly straight lines and corners.

You get professional-looking data every time.



Underline *Editing screen*

Centering

Indent

Diagram

Italic face

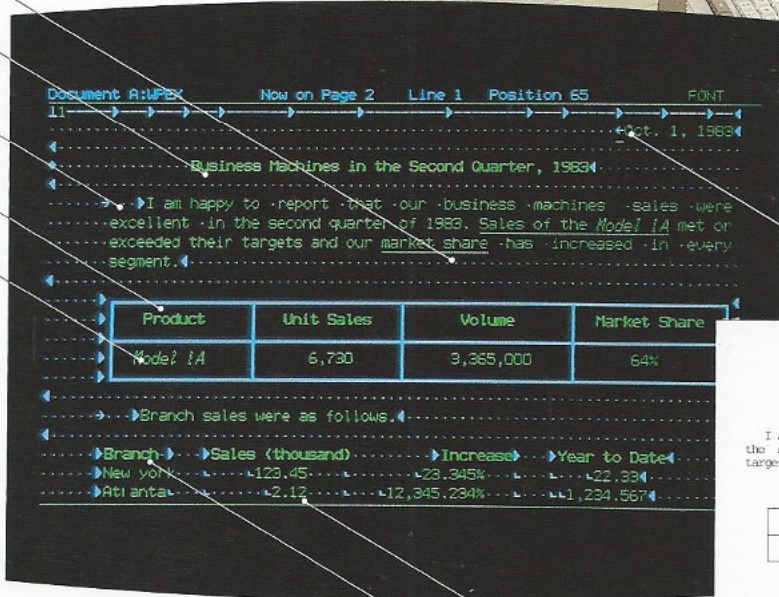

Ragged left

Sample printout with the AP-500 electronic typewriter

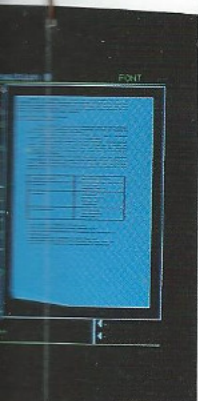

Decimal tab

Bold face

Oct. 1, 1983

Business Machines in the Second Quarter, 1983

I am happy to report that our business machines sales were excellent in the second quarter of 1983. Sales of the Model 1A met or exceeded their targets and our market share has increased in every segment.

Product	Unit Sales	Volume	Market Share
Model 1A	6,730	3,365,000	64%

Branch sales were as follows.

Branch	Sales (thousand)	Increase	Year to Date
New York	123.45	23.345%	22.33
Atlanta	2.12	12,345.234%	1,234.567
Chicago	223.2	232.431%	123.234

**Thousands of application programs run on the AS-100.**

Sometimes you need more specialized computing power. Then you can use the AS-100 like a regular stand-alone microcomputer. No matter what your field, no matter what decisions you have to make, there are programs which will turn the AS-100 microcomputer into the perfect tool for you.

Using operating systems enhanced by Canon for flexibility and ease of use, local software specialists can offer inventory control, accounts receivable,

accounts payable, general ledger, and more for your AS-100. It's a cost-effective way to build your software library and get the most out of your AS-100.

**Easy to program for, too.**

The AS-100 runs several programming languages. It makes development of original software easier.

Whatever your EDP staff is expert in—COBOL, BASIC, Assembler, or other languages—they can work with a familiar language. That makes the process faster—and improves the quality, too.

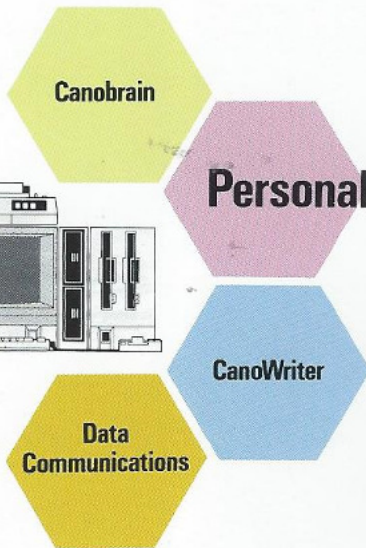

## Personal Business Computer

# The tool that's ready for anything

**Multiple operating systems and multi-language programming.**

The AS-100 gives you a choice of operating systems—the heart of the computer's performance. They are CP/M-86™ and MS-DOS™—the world's most popular operating systems for microcomputers.

The AS-100's operating systems are also enhanced to take advantage of its special hardware capabilities.

The most obvious advantage of this architecture is that you can choose and run thousands of readymade, popular application programs like Word Star™, dBASE II™, and more.

Another advantage is that the AS-100's multiple operating systems support several programming languages. Your EDP staff can choose the language they prefer from the point of view of training, development speed, cost, or functions.

**Exclusive application and utility programs from Canon.**

In addition to the integrated Canobrain™ package and CanoWriter™, many application programs are written especially for the AS-100. Software available from Canon includes inventory control, accounts receivable, accounts payable, general ledger, and others.

*TM: CanoWriter and Canobrain are trademarks of Canon Inc. CP/M-86 is a trademark of Digital Research, Inc. MS-DOS and GW-BASIC are trademarks of Microsoft Corp. Level-II COBOL is a trademark of Micro Focus Ltd. UCSD P-System, UCSD Pascal, and UCSD Fortran are trademarks of the Regents of the University of California. WordStar is a trademark of Micro Pro International Corp. dBASE II is a trademark of Ashton-Tate.*

**Versatile AS-100 software**

<b>Operating Systems:</b> CP/M-86™, MS-DOS™-Version 1 or 2, UCSD P-System™
<b>Languages:</b> Canon BASIC, GW-BASIC™ (Compiler), Level II COBOL™ UCSD PASCAL™, UCSD FORTRAN™
<b>Information Manager:</b> Canobrain™ (CanoCalc, CanoGraph, CanoFile), CanoWriter™
<b>Utilities:</b> RJE-86 (IBM3780 Emulator), CICS-86 (IBM3270 Emulator)

**Choice of memory and external storage capacity.**

The AS-100 offers an exceptionally wide range of choices in memory configuration, a key hardware characteristic.

In main memory, choose 128, 256, 384, or 512 K bytes. Naturally, you can upgrade to another level later.

In external storage, choose from three types of disk drives.

- The A-1300 double-deck 5-inch mini floppy disk drive accommodates two double-sided, double-density, double-track disks. Each stores 640 K bytes.
- The A-1330 double-deck 8-inch floppy disk drive accommodates two double-sided, double-density disks. Each stores 1.2 M bytes.
- The A-1350 5-inch Winchester-type hard disk unit comes with a 5-inch floppy disk drive. The hard floppy stores up to 8.5 M bytes and the 5-inch disk stores 640 K bytes (formatted). The A-1350S model has hard disk without the floppy disk drive.

Hardware and software may change depending on the market.

**And expandable enough to grow with you.**

The AS-100 isn't really just a microcomputer—it's a complete computing system to fit any need.

Need more data storage capacity for a growing job volume? The AS-100 can accommodate you.

Need a special fast printer, one that handles color, or one for correspondence? The AS-100 can take any of them.

Need to link your computer with special devices? The AS-100 has a variety of interfaces for convenience.

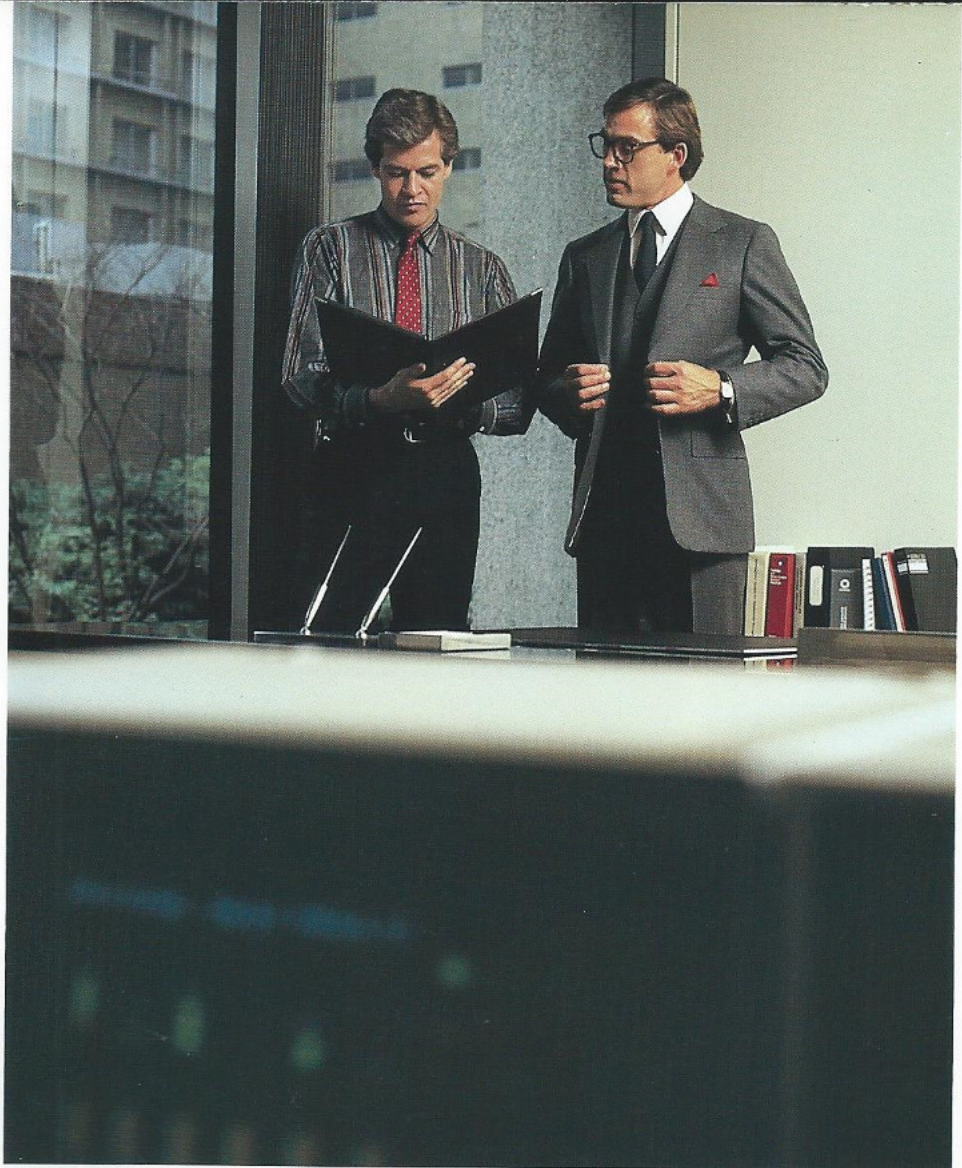

ng.

**Printers and display units to meet any need.**

The AS-100 offers a range of printers and display units. Choose the best combination for your job.

Monochrome (AS-100M) and color (AS-100C) display units are both available. Both 12-inch units are designed for graphic display with 600 x 400 dot resolution. The display is attached to a high-speed graphic processing circuit. With the color monitor, you can choose eight out of 27 colors on a palette-type color handling system.

Printers available include color, high speed, graphic, and wide platen models or electronic typewriters. Three were designed especially for the AS-100.

- The A-1210 is a seven-color printer with graphic capability.
- The A-1200 is an 80-column wire-dot printer with graphic capability.
- The A-1250 is a 156-column wire-dot printer with graphic and near-letter-quality printing capability.

**And optional hardware, too.**

Several optional devices make the AS-100 a more flexible tool for your office.

The A-1100 Pointing Device is a cursor controller which makes operation easier.

There are also special keyboards available for French, German, and other languages.

ROW DATE: 07-29-80      \*\*\* GENERAL LEDGER SYSTEM \*\*\*      PAGE: 1

\*\*\*\*\* BALANCE SHEET \*\*\*\*\*

1-ASSET 1	11-ASSET 1	12-ASSET 1	13-ASSET 1	14-ASSET 1	15-ASSET 1	16-ASSET 1	17-ASSET 1	18-ASSET 1	19-ASSET 1	20-ASSET 1	21-ASSET 1	22-ASSET 1	23-ASSET 1	24-ASSET 1	25-ASSET 1	26-ASSET 1	27-ASSET 1	28-ASSET 1	29-ASSET 1	30-ASSET 1	31-ASSET 1	32-ASSET 1	33-ASSET 1	34-ASSET 1	35-ASSET 1	36-ASSET 1	37-ASSET 1	38-ASSET 1	39-ASSET 1	40-ASSET 1	41-ASSET 1	42-ASSET 1	43-ASSET 1	44-ASSET 1	45-ASSET 1	46-ASSET 1	47-ASSET 1	48-ASSET 1	49-ASSET 1	50-ASSET 1																																																		
11-4010	17-4015	12-4020	13-4025	14-4030	15-4035	16-4040	17-4045	18-4050	19-4055	20-4060	21-4065	22-4070	23-4075	24-4080	25-4085	26-4090	27-4095	28-4100	29-4105	30-4110	31-4115	32-4120	33-4125	34-4130	35-4135	36-4140	37-4145	38-4150	39-4155	40-4160	41-4165	42-4170	43-4175	44-4180	45-4185	46-4190	47-4195	48-4200	49-4205	50-4210	51-4215	52-4220	53-4225	54-4230	55-4235	56-4240	57-4245	58-4250	59-4255	60-4260	61-4265	62-4270	63-4275	64-4280	65-4285	66-4290	67-4295	68-4300	69-4305	70-4310	71-4315	72-4320	73-4325	74-4330	75-4335	76-4340	77-4345	78-4350	79-4355	80-4360	81-4365	82-4370	83-4375	84-4380	85-4385	86-4390	87-4395	88-4400	89-4405	90-4410	91-4415	92-4420	93-4425	94-4430	95-4435	96-4440	97-4445	98-4450	99-4455	100-4460

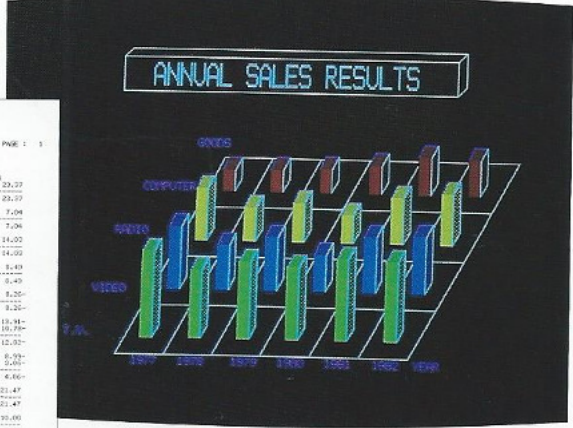

**Access to information inside and outside the company makes your decisions faster and better.**

Compared to ordinary microcomputers, the AS-100 has an important advantage: it can be connected to your mainframe computer as a terminal. It lets you enter data into the mainframe files right from your AS-100. You can also pull information the other way—from the host computer into your AS-100. And even use the mainframe's computing power to solve a problem from the AS-100 keyboard.

With this kind of information access, you have all the ammunition you need for better decisions.

**Stay connected in your office.**

The latest trend in office automation is the Local Area Network (LAN). It connects a number of AS-100s and other machines in the same building via a cable.

That way, you can send information—or even electronic mail—to anyone else on the LAN system. By the same token, you also have access to other LAN users' data when you need it. Eventually, other Canon business machines may be included in a LAN.

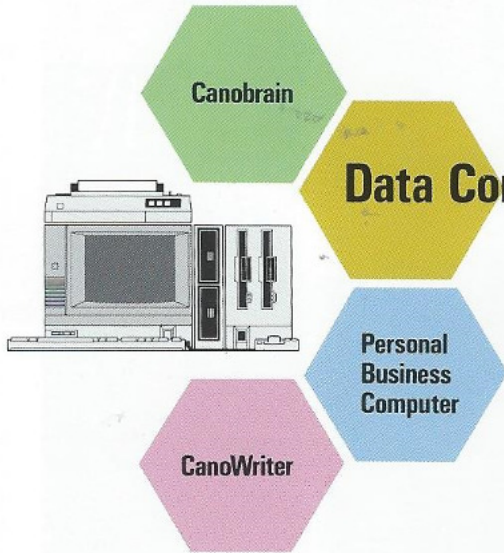

**Data Communications**

*The tool that puts the world at*

The AS-100's communications capabilities make it a versatile addition to your computing power.

**Using the AS-100 with a mainframe computer.**

The AS-100 can be equipped with both RJE-86 and CICS-86 emulators. These two software utilities make it possible to use the AS-100 as an intelligent terminal of a mainframe computer.

The RJE-86 is an emulator program of the remote batch terminal IBM 3780. This program realizes remote job entry (RJE) and file transfer between a mainframe and the AS-100.

With the RJE function, you can send job control language or source programs right from the AS-100's disks to the host computer for compiling or other processing. Then the results are returned to your AS-100.

The RJE file transfer function also provides for movement of documents and data between the AS-100 and the host computer. The RJE also supports

communication between terminals such as another AS-100, another personal computer, or an IBM 3741 remote terminal.

The CICS-86 is an emulator program for the IBM 3270 video terminal. This program also makes data communication between the mainframe computer and the AS-100 possible.

**Using the AS-100 in a Local Area Network.**

To get the full benefits of office automation, stand-alone machines must be linked together to share information. The AS-100 provides for this set-up with a Local Area Network (LAN) interface for the CORVUS OMNINET.<sup>TM</sup>

As a LAN member, you'll find yourself sending electronic mail or messages to other managers who have AS-100s. Electronic mail is fast and convenient.

LANs allow use of your next-door neighbor's data base for a special calculation.

A LAN really makes office automation come alive.

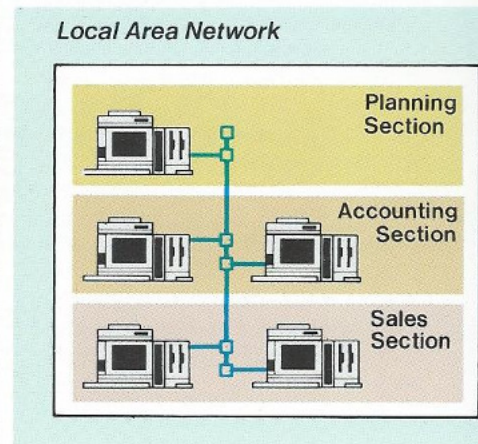
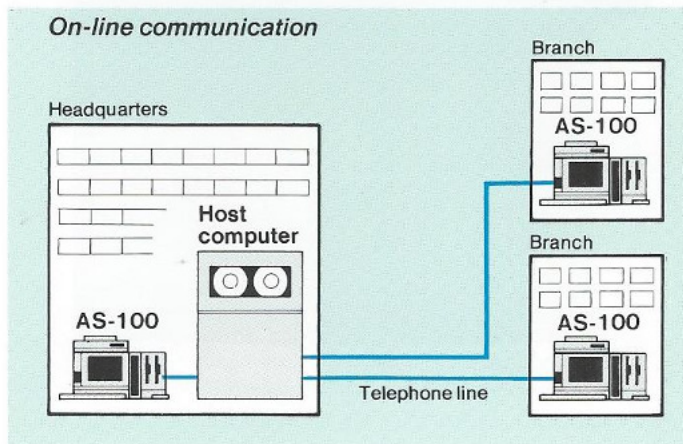

In this way, the AS-100 could easily become the nerve center of your office.

**Keep your data up-to-the-minute with in-field communication terminals.**

Some industries use batteries of route sales or delivery people—especially soft drink or packaged product sales. If your company has people making sales in the field, you can keep a running total of sales and inventory by using the AS-100 with handy terminals.

The salesman just enters his volume or collects data on the spot. Then he sends the data in the handy terminal to the AS-100 through telephone lines or by direct connection.

# your fingertips.

**Using the AS-100 as a host for portable terminals.**

Until now, office automation has been mainly confined—as the name implies—to the office. Now, the AS-100 lets you extend the benefits of office automation right out of your office and into the field.

The key is a system of portable “handy terminals.” Programs developed and stored by the AS-100 can be transferred to the handy terminal. Out in the field, data entered into a handy terminal can be transferred to the AS-100 through a direct cable, or right from any telephone. The terminals are small and light enough to carry in a briefcase or wear around the neck.

You'll find them especially useful if, for example, you have a complex delivery or inventory set-up that requires daily or weekly rounds of checking.

Canon's Handy Terminal 5000, for example, has up to 32 K bytes of internal user RAM plus optional file memory in a

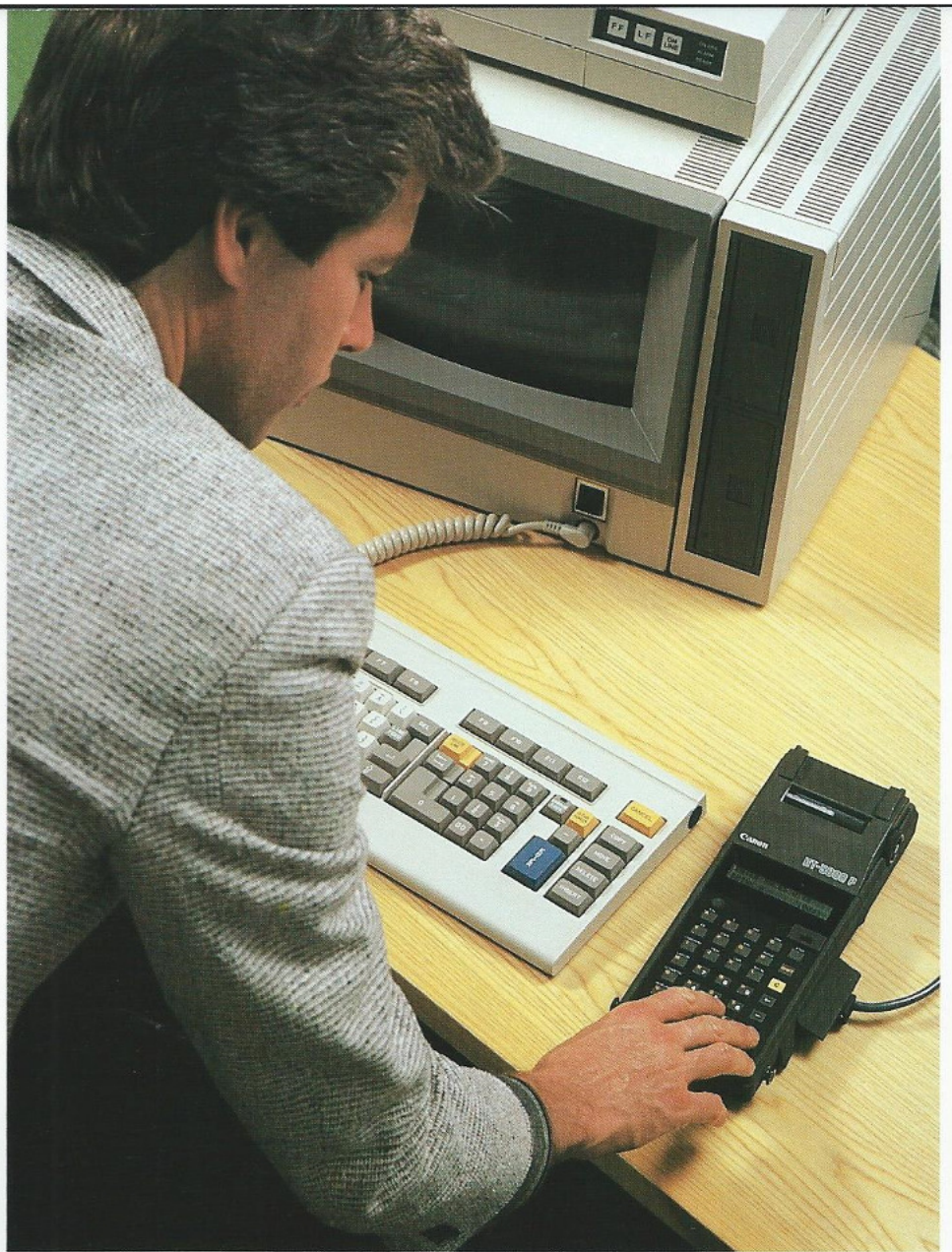

RAM pack. It's available with or without printer, sends data via an RS232C interface, and accepts a bar code reader as an option. The Handy Terminal 5000 is able to run programs written in BASIC on the AS-100.

*TM: OMNINET is a trademark of CORVUS Systems Inc.*

*Hardware and software may change depending on the market.*

**Outdoor OA**

Three possible configurations of the AS-100 and the Handy Terminal 5000

Data collection



Data collection and transmission

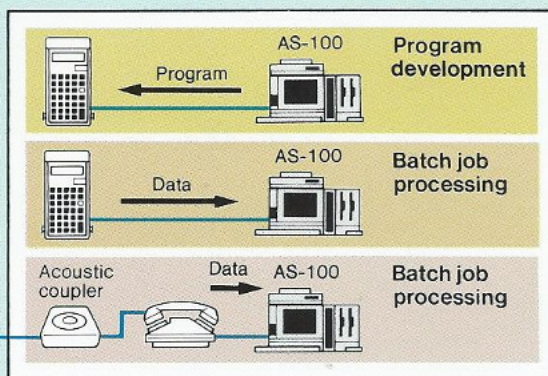
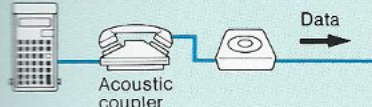

# Why choose only one computer when you can

Choose Canon's AS-100—the tool that actually helps you make faster, better decisions. The AS-100—with Canobrain as an idea generator, with CanoWriter for all your documents and letters, as a personal business computer with all the application programs you need, or as a data communications terminal to keep you connected in or out of the office.

*The Canon AS-100. Tool for decision-makers.*

#### A-1210 Color Printer

- 7-color ink-jet printing capability
- 80-column normal character printing capability
- High-resolution graphics capability

#### AS-100C/M Display Unit

#### A-1111 ASCII Keyboard

#### A-1300 Mini Floppy Disk Drive Unit

- 5-inch double-sided, double-density, double-track mini floppy disk unit with capacity of 640 K bytes each
- Double-deck disk drives
- Total storage capacity of 1,280 K bytes

#### A-1100 Pointing Device



*n have four?*



**A-1250 Dot Impact Printer**

- 156-column normal character printing capability
- Condensed, enlarged, and near-letter-quality characters available
- High-resolution graphics capability



**A-1200 Dot Impact Printer**

- 80-column normal character printing capability
- Condensed and enlarged characters available
- High-resolution graphics capability



**A-1330 Floppy Disk Drive Unit**

- 8-inch double-sided, double-density floppy disks with capacity of 1.2 M bytes each
- Double-deck disk drives
- Total storage capacity of 2.4 M bytes



**A-1350 Hard Disk Unit**

- 5-inch Winchester-type hard disk unit
- One-deck 5-inch mini floppy disk drive (model A-1350S is without mini floppy disk drive)
- Total storage capacity of 9.14 M bytes formatted

# Canon CANON INC.

7-1, Nishi-shinjuku 2-chome, Shinjuku-ku, Tokyo 160, Japan  
P.O. Box 5050, Shinjuku Dai-ichi Seimei Building, Tokyo 160, Japan

## CANON U.S.A., INC.

HEAD OFFICE One Canon Plaza, Lake Success, Long Island, N.Y. 11042, U.S.A.  
CHICAGO 140 Industrial Drive, Elmhurst, Illinois 60126, U.S.A.  
LOS ANGELES 123 Paularino Avenue East, Costa Mesa, California 92626, U.S.A.  
ATLANTA 6380 Peachtree Industrial Blvd., Norcross, Georgia 30071, U.S.A.  
DALLAS 2035 Royal Lane, Suite 290, Dallas, Texas 75229, U.S.A.

## CANON CANADA INC.

HEAD OFFICE 3245 American Drive, Mississauga, Ontario, L4V 1N4, Canada  
CALGARY 2828, 16th Street, N.E. Calgary, Alberta, T2E 7K7, Canada

## CANON EUROPA N.V.

P.O. Box 7907, 1008 AC Amsterdam, The Netherlands

## CANON FRANCE S.A.

Centre D'Affaires Paris-Nord, Immeuble Ampère 5, 93151 Le Blanc Mesnil, Cedex, France

## CANON U.K. LTD.

Waddon House, Stafford Road, Croydon CR9 4DD, England

## CANON RECHNER DEUTSCHLAND GmbH

P.O. Box 1209, 8033 München-Martinsried, West Germany

## CANON LATIN AMERICA, INC.

SALES DEPARTMENT P.O. Box 7022, Panama 5, Rep. of Panama

REPAIR SERVICE CENTER P.O. Box 2019, Colon Free Zone, Rep. of Panama

## CANON HONGKONG TRADING CO., LTD.

Golden Baar Industrial Centre, 7th Floor, 66-82 Chai Wan Kok Street, Tsuen Wan, New Territories, Hong Kong

## CANON AUSTRALIA PTY. LTD.

1 Hall Street, Hawthorn East, Victoria 3123, Australia