

System 80

USER'S MANUAL

PREFACE

This manual is a guide that helps you to get familiar with the System 80 in the quickest manner. It helps you to set up the system and to operate it efficiently. An overview of the System 80 is provided so that you will find no difficulty in understanding and expanding your system. Moreover, higher level computer users will find the technical information in the APPENDIX very useful. In case you have any problem or any suggestion, don't hesitate to contact your local dealers. Welcome to the exciting world of personal computing.

'You are welcome!'

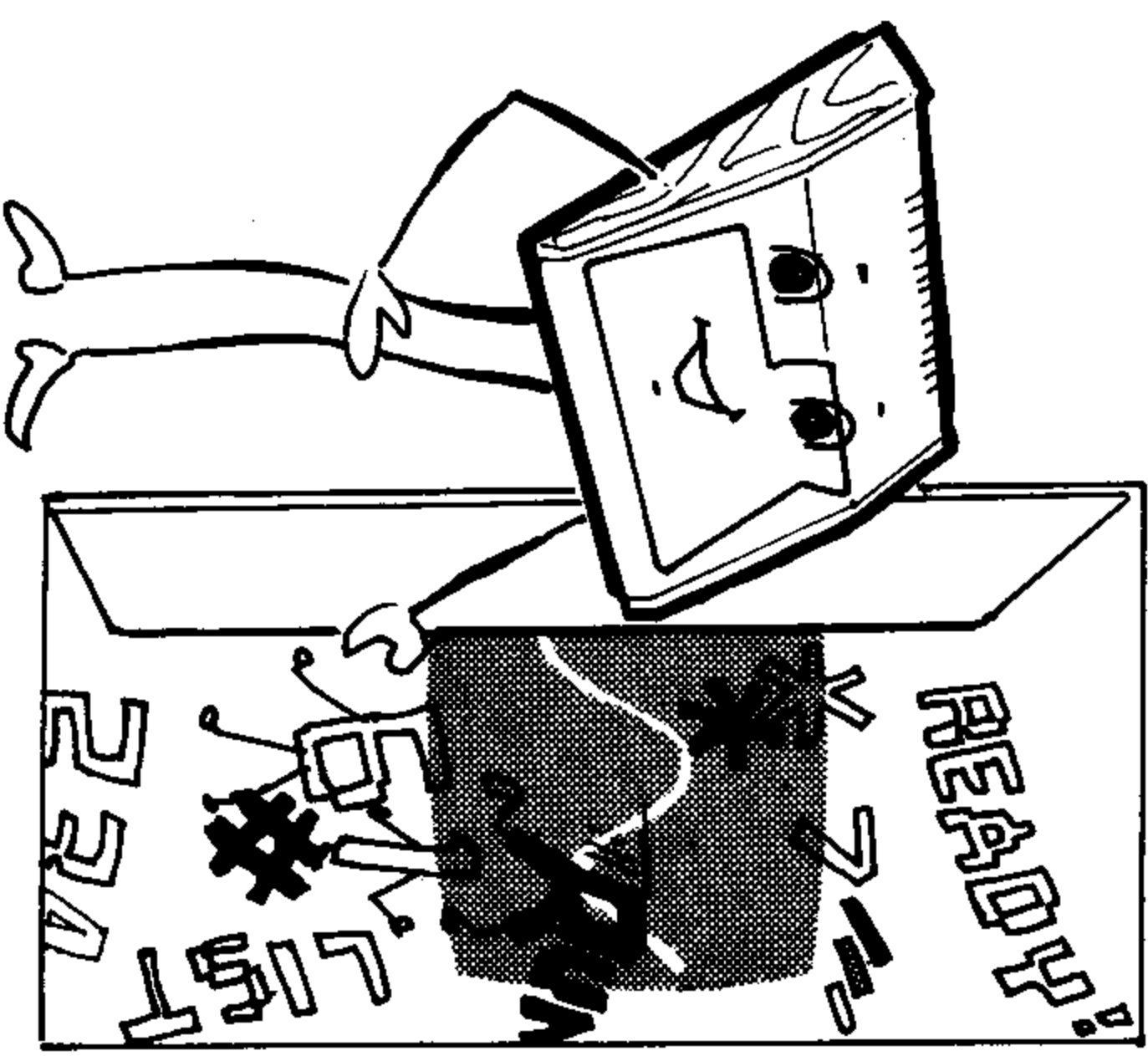

CONTENTS

Page

TABLE OF CONTENTS

1. Introduction	3
2. Power On Preparation	5
3. Video Display format	6
4. Keyboard and Cassette	7
5. Program loading	8
6. Program Saving	10
7. Second Cassette Recorder	11
8. System Reset	12
9. Software	12

APPENDIX

- A. Technical specifications
 - B. Memory map and I/O map
 - C. ASCII table
- ### SOUND OUTPUT

Now, you can enjoy programs with music and star war sound effect. Your GENIE already has a speaker connected to the cassette interface output.

INTRODUCTION 1

The design philosophy of the System 80 is like that of most other general purpose computer systems, and has great expansion capability. The main unit (EG3003/4) contains a Central Processing Unit, I/O devices and a mass storage device. These are the Z80 CPU, a keyboard, a video interface and a resident cassette recorder. The EG3003 has resident 16 Kilobytes of RAM (Random Access Memory) for user's program storage, while the EG3004 has only 4K. The system has a video interface and an RF modulator to display the information on a VDU or a TV.

Fig. 1.1

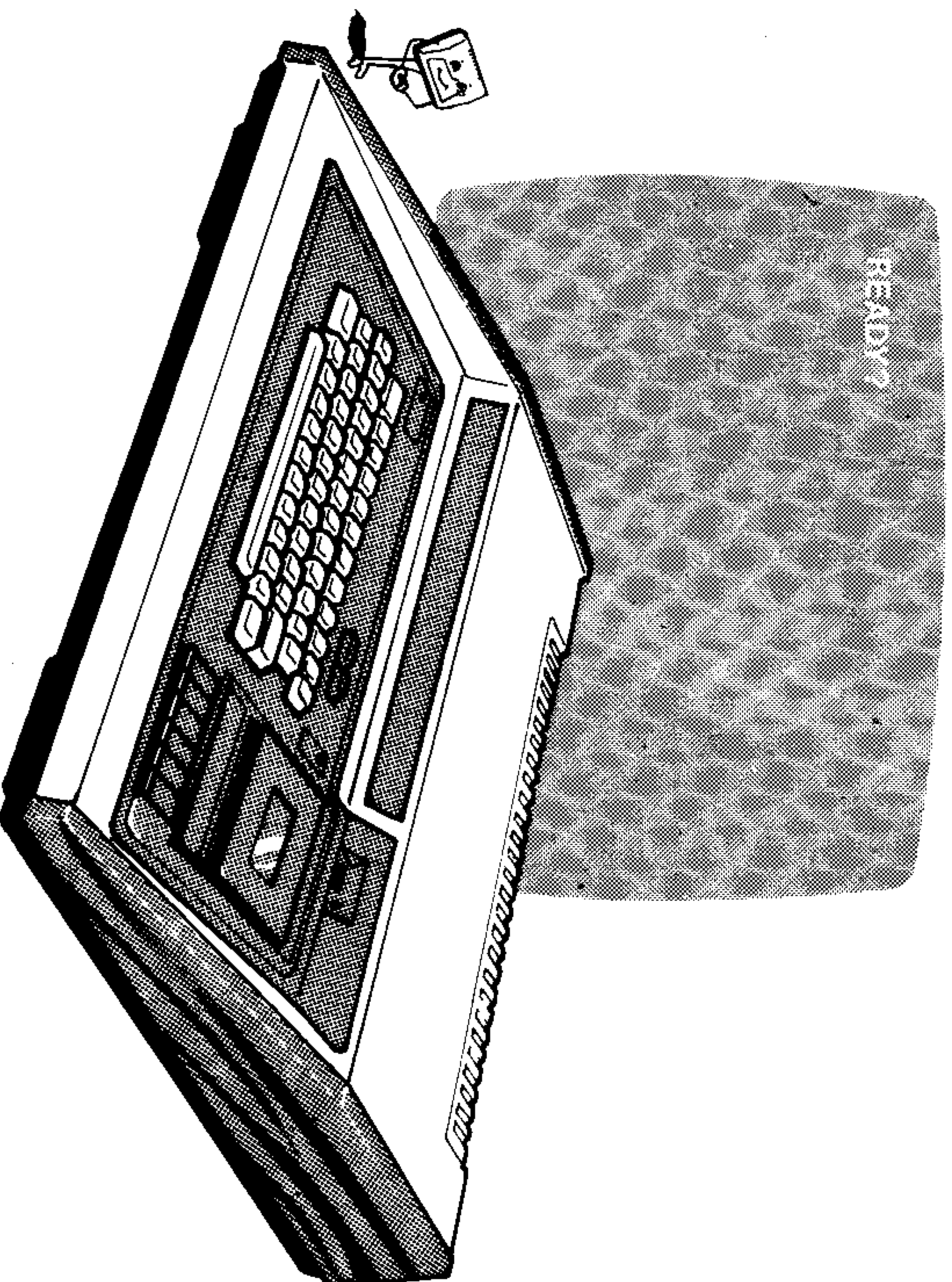

Beside the hardware configuration described, the System 80 has a powerful resident EXTENDED BASIC Interpreter which is compatible with that of TRS-80 Level II BASIC.

An optional S-100 bus expansion box is designed to be connected to the main unit. More peripherals can then be linked to the system by plugging their standard interface cards into the S-100 bus mother-board. S-100 bus is now a standard in the micro-computer industry, especially for computers using 8080 or Z-80 CPUs.

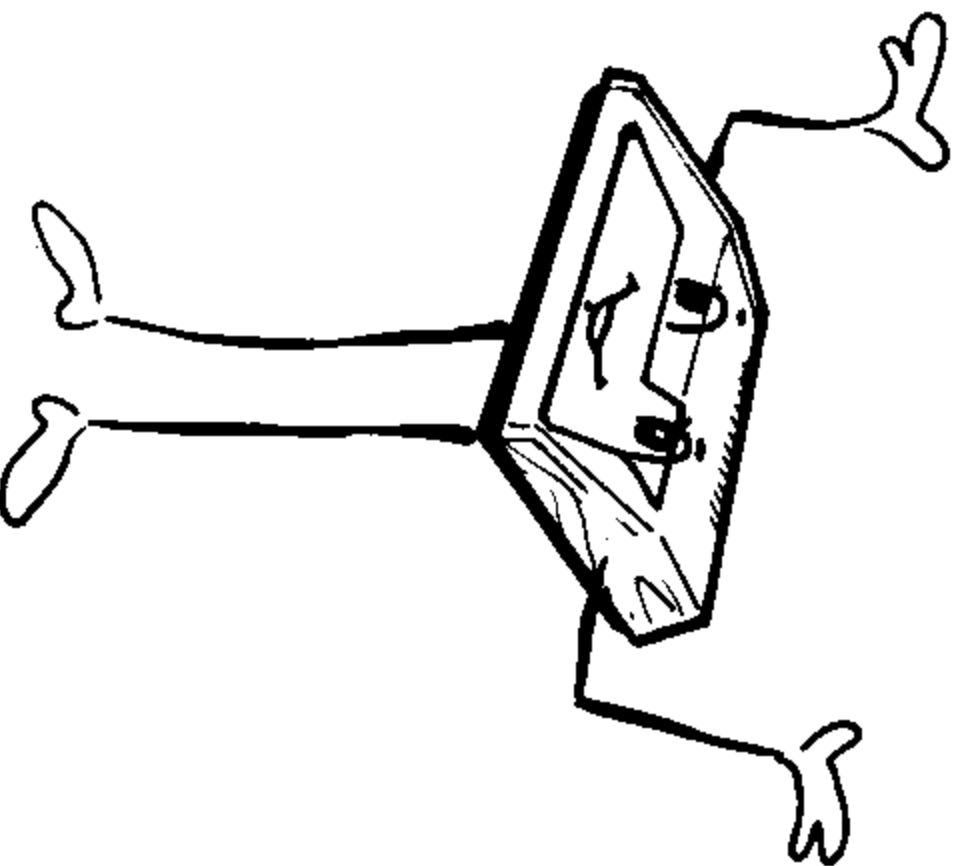
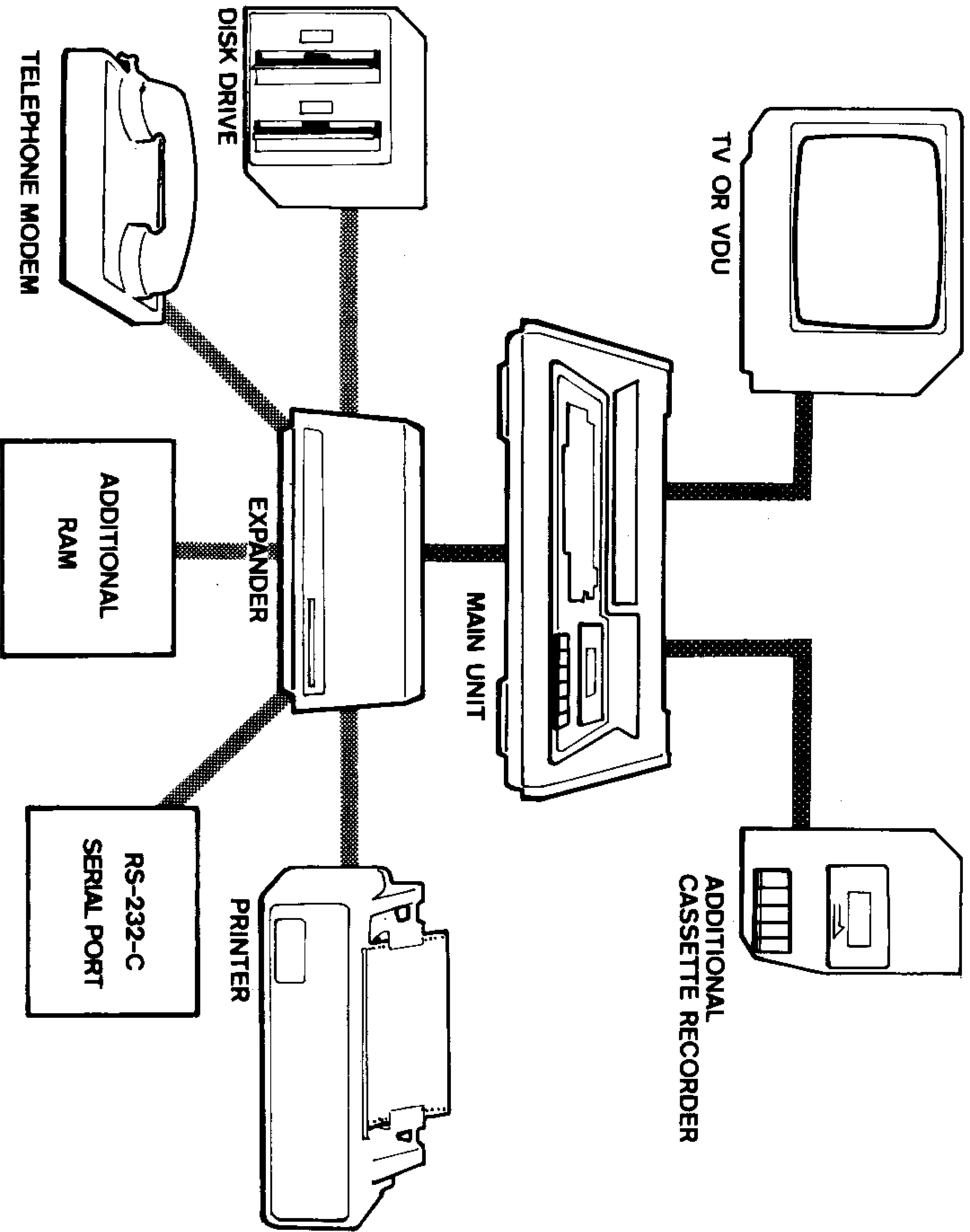

'This is my family!'

The System 80 is ready to operate immediately after unpacking from the carton box. However, the user should adhere to the following procedures.

POWER ON PREPARATION 2

- a Ensure that the power switch is in the 'off' position.
- b Check whether the AC voltage labelled on the power supply unit is the same as that of your country.
- c Connect the power plug to a power line socket.
- d Connect a Video Display Unit to the system. The Unit can either be an ordinary TV set or a video monitor.
- e Ensure that the 'Video Cut' switch at the back panel is at the 'out' position. The display format will be 64 characters/line.
- f Turn on the power of the display unit first, then the System 80.
- g A message 'READY?' will be displayed on the top left corner of the display.
- h If no 'READY?' message is displayed, go to step (a) and check again.
- i After the 'READY?' message appears, the user should hit the NEWLINE key, then another 'READY?' message should appear on the bottom left corner of the display.
- j Now, the System is at the Active Command level. You can type in commands to get the computer to work for you. Please refer to the Programming Manual for all the Active Commands available.
- k If you want to have another display format, please read the next section.

NOTE: If the power switch is turned off for any reason, the user should wait at least 15 seconds before turning the power switch on again.

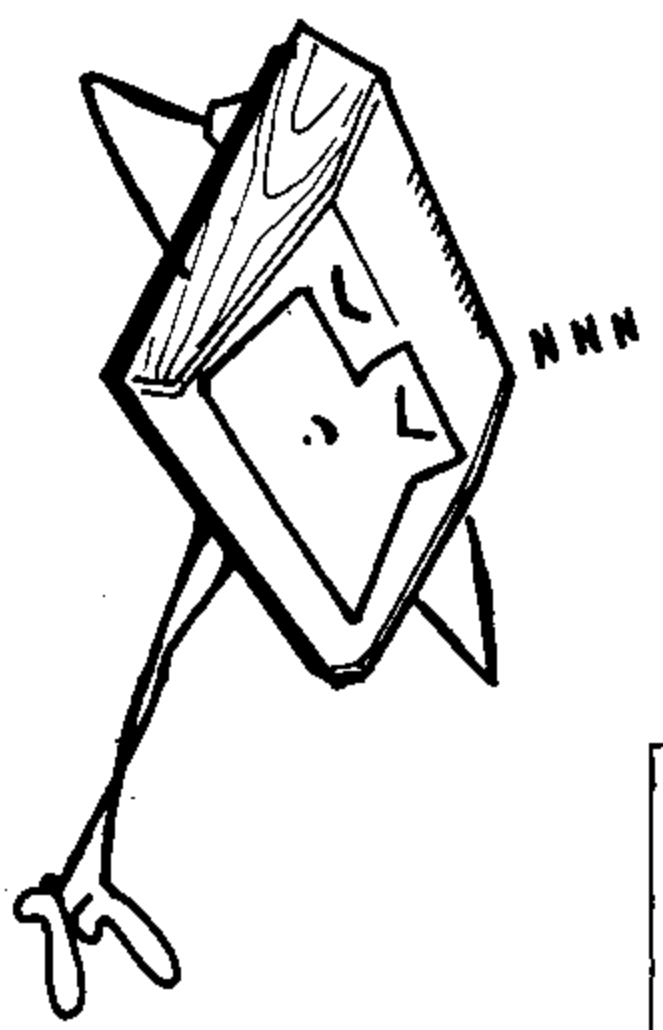
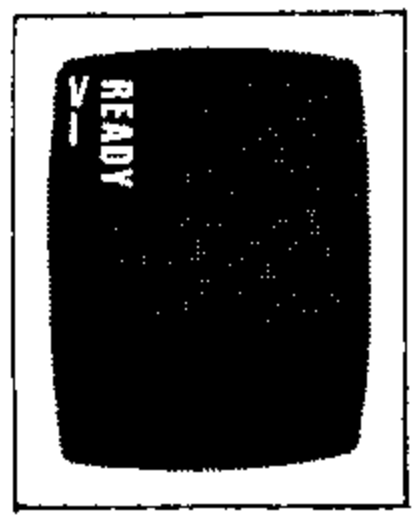
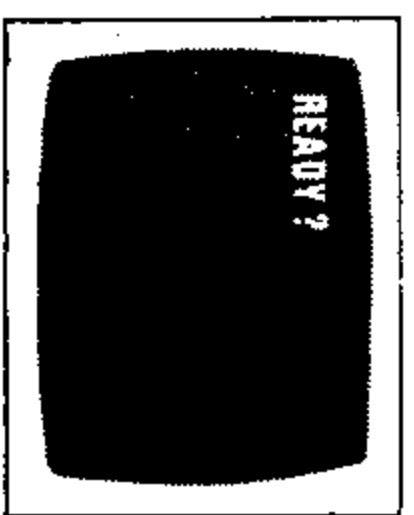
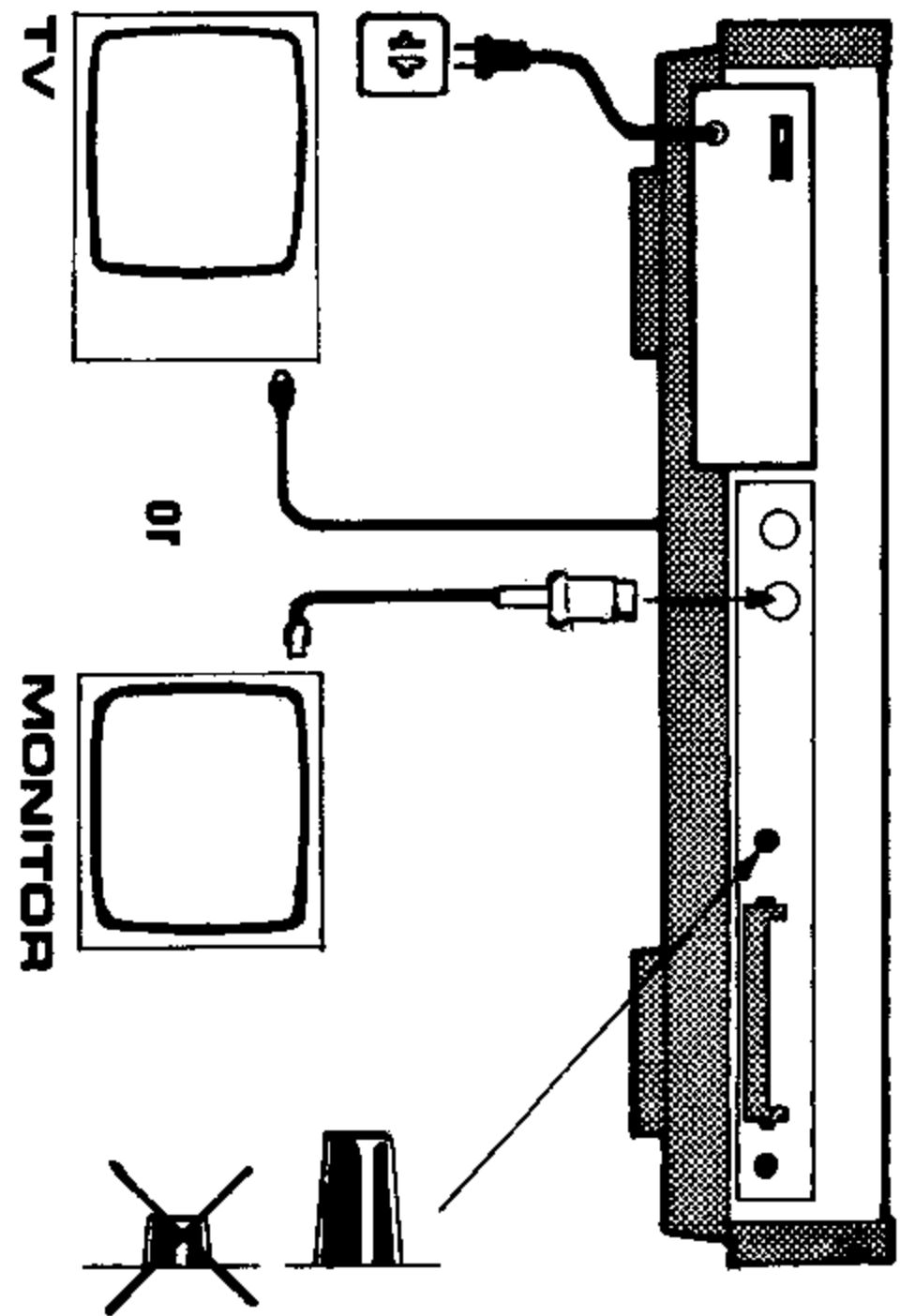

3.1 FORMAT SELECTION

The System 80 allows two kinds of display formats, that is, (1). 64 characters per line; (2) 32 characters per line. The purpose of the latter is to permit an enlarged and clear character display when a television set is used.

3.2 64 CHARACTERS/LINE FORMAT

The 64 characters per line format is selected whenever the computer is turned on and the VIDEO CUT button is off. The user may select 32 characters per line by pressing the VIDEO CUT button.

3.3 32 CHARACTERS/LINE FORMAT

- a) Press the VIDEO CUT button on the back panel.
- b) Press the PAGE button on the front panel to read either the left half or the right half of the text on the display.

3.4 SPACE INSERTION

A space can be inserted automatically between characters by typing in PRINT CHR\$(23) This mode will be reset by NEW or CLS command.

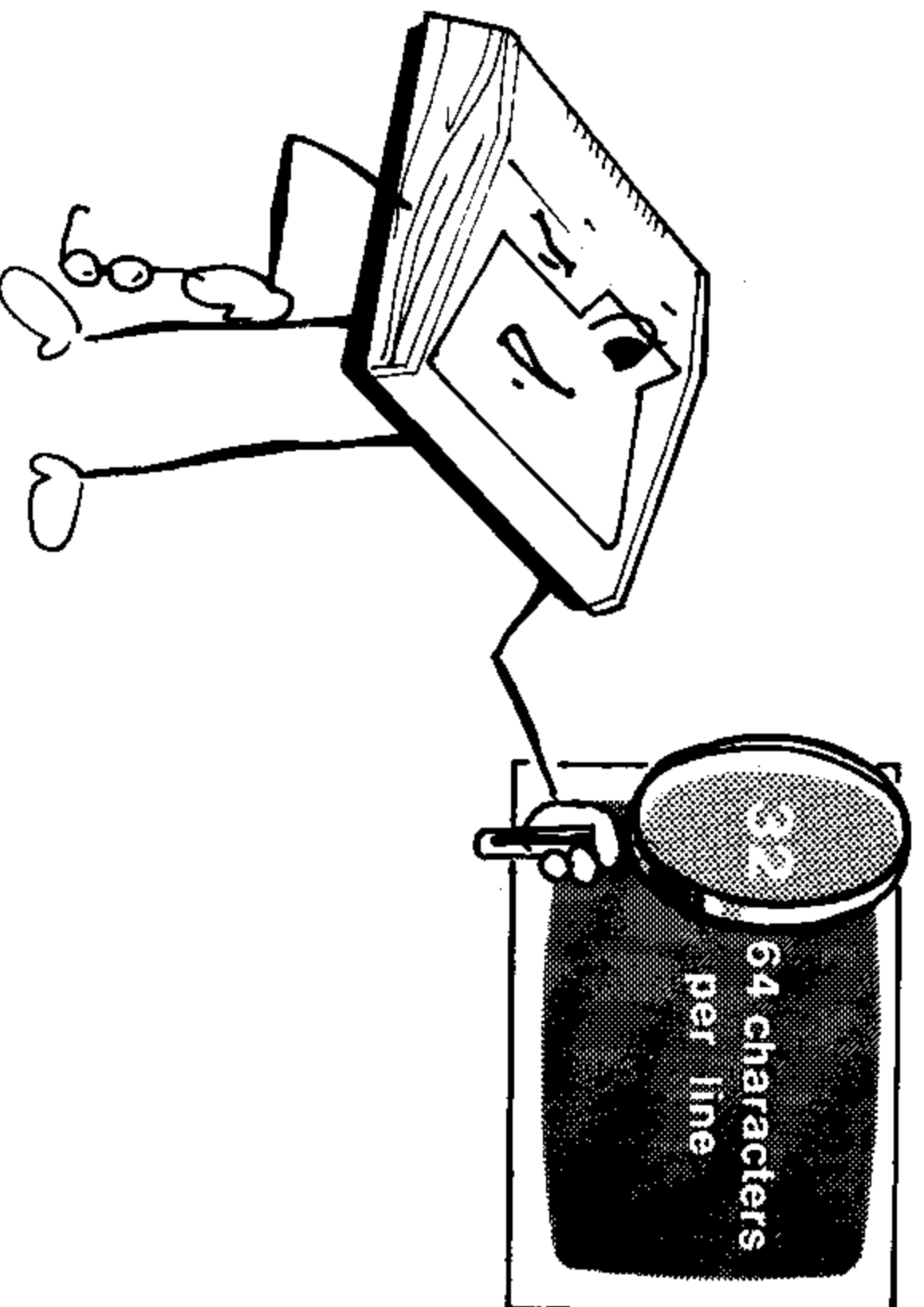

VIDEO DISPLAY 3 FORMAT

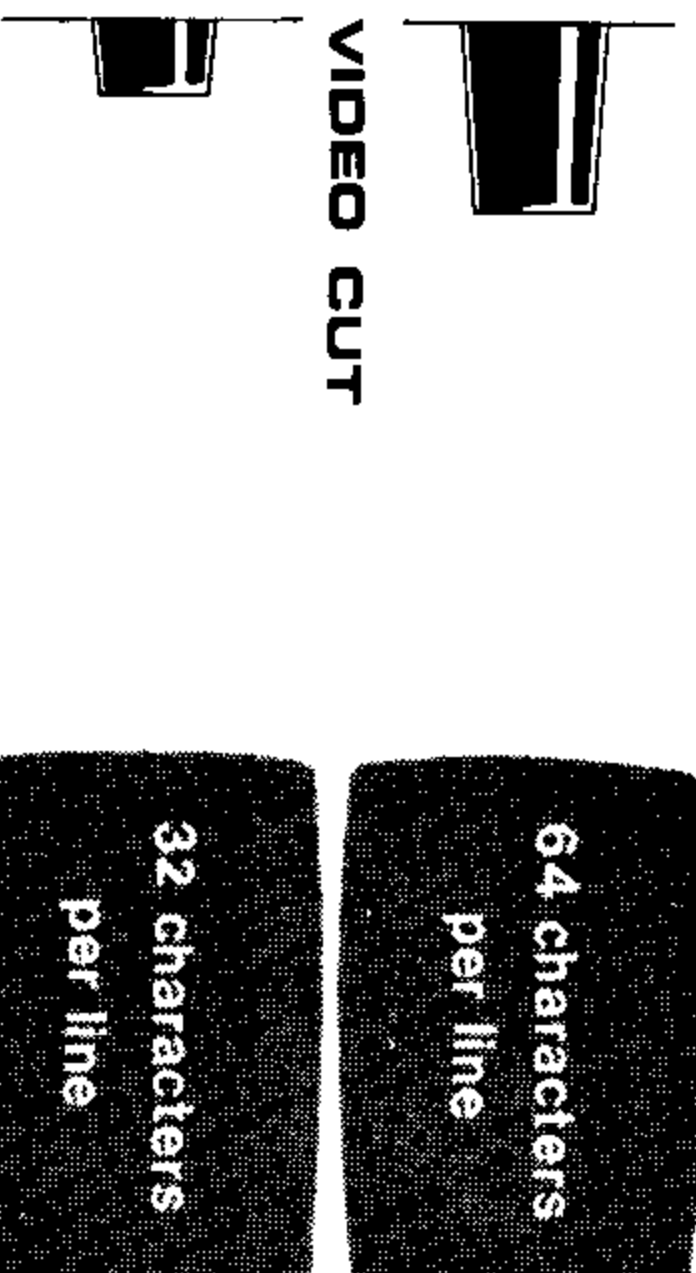

The keyboard acts as a man-machine interface, while the cassette is used for mass storage of programs and data.

KEYBOARD & CASSETTE 4

4.1 Special Function Keys

- PAGE** — select page for display (refer to previous section).
- F1** — isolate the cassette from the control of the computer during winding and rewinding and allow manual cassette motor control.
- BREAK** — break a running program and return to the Active Command Level.
- NEWLINE** — enter a line of command or data into the computer.
- BACKSPACE** — cancel the character previously typed.
- ESC** — the display echoes a [sign which is an exponent sign used by the System.
- CTL** — move the cursor to the beginning of the next line.
- SHIFT/CTL/I** — tab function; move the cursor 8 spaces to the right.
- SHIFT/CTL/Y** — same as print CHR\$(23). See section 3.4
- SHIFT/BACKSPACE** — delete line.

4.2 Cassette Recorder

The cassette recorder is a high fidelity audio recorder. It has six piano keys and a 3-digit counter. The keys function the same as those of a normal recorder. The user should take the advantage of the counter for fast program locating.

Program loading and saving will be discussed in detail in next section.

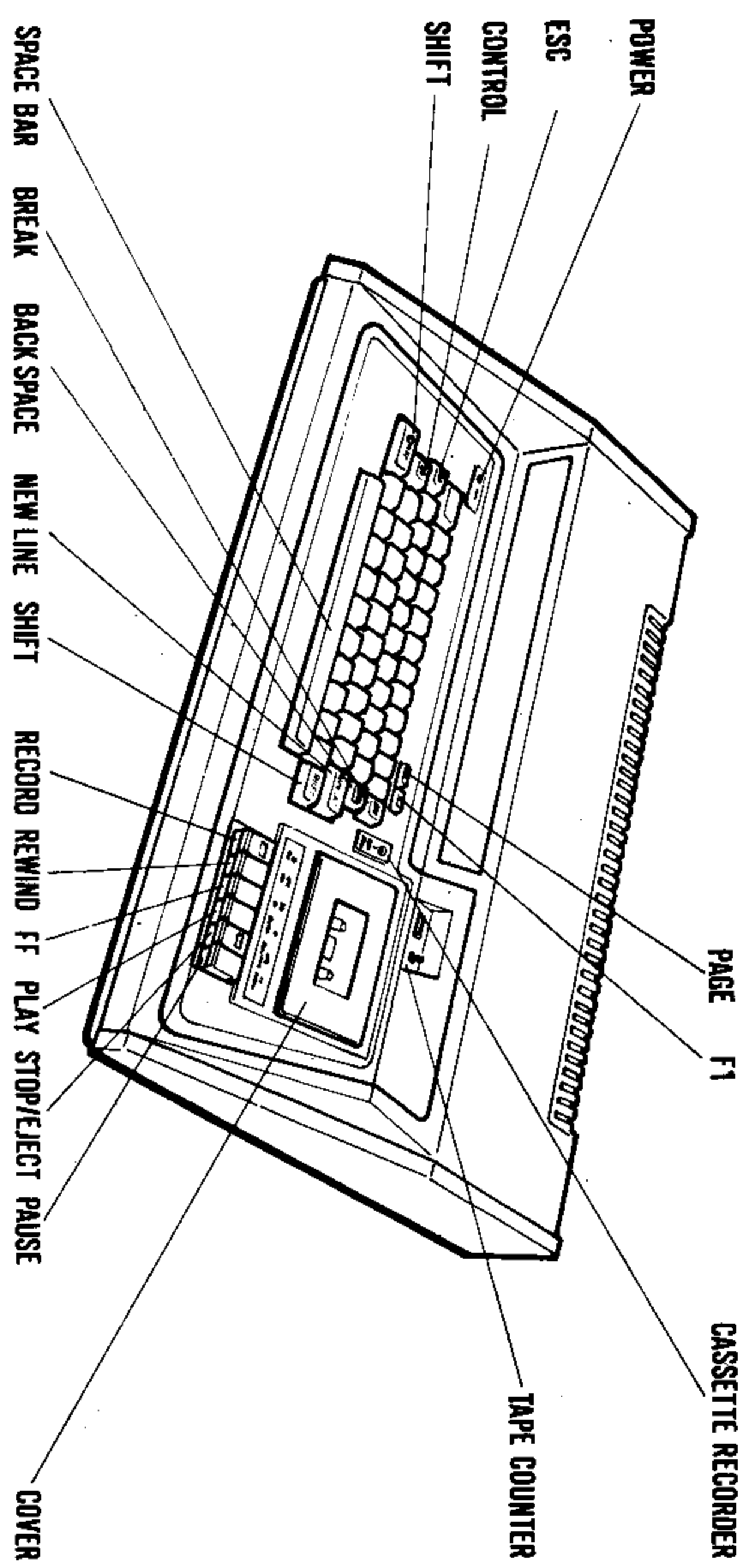

PROGRAM LOADING

5

REWINDING

Programs are stored on the cassette tapes in the form of magnetic signals. If the user wants his Computer to do a certain job, he should write the program, save it onto a cassette tape and then reload the program into the system at any time he wants. He may also buy any TRS80 Level II Basic compatible tapes from the computer market, then load and run them. The cassette interface is designed to accept a wide range of input signal levels, therefore, no volume adjustment is required.

Now, please follow the procedures below and try to load the demonstration programs supplied with your System.

5.1 Loading a program from the resident cassette (cassette no. 1)

- Insert a cassette into the recorder.
- Close the cover of the recorder.
- Rewind the tape if necessary. (see section 5.2)
- If you know where is the program located, wind the tape until the counter indicates the position of the program's beginning.
- Type in CLOAD#-1,"N" (where N represents the name of the program) or, type in CLOAD. The former command tells the computer to search for the suitably named file, while the second command will only load the first file encountered.
- Press the PLAY key on the cassette drive.
- Hit the NEWLINE key.

At this point, the computer starts searching for the program mentioned in the CLOAD command; once it is found, two asterisks will appear at the top right corner of the display, the one on the right will be flashing from time to time indicating the program is loading. A READY message will appear once the loading has been completed.

5.2 Rewinding Procedure

- Check if the power switch of the computer is turned ON.
- Press the F1 key (the red light labelled CASSETTE RECORDER should be on also).
- Press the REWIND button on the cassette drive.
- Wait till rewinding stops.
- Press the STOP/EJECT button to stop all operations physically.
- Reset the cassette counter to 000.
- Turn off the F1 button.

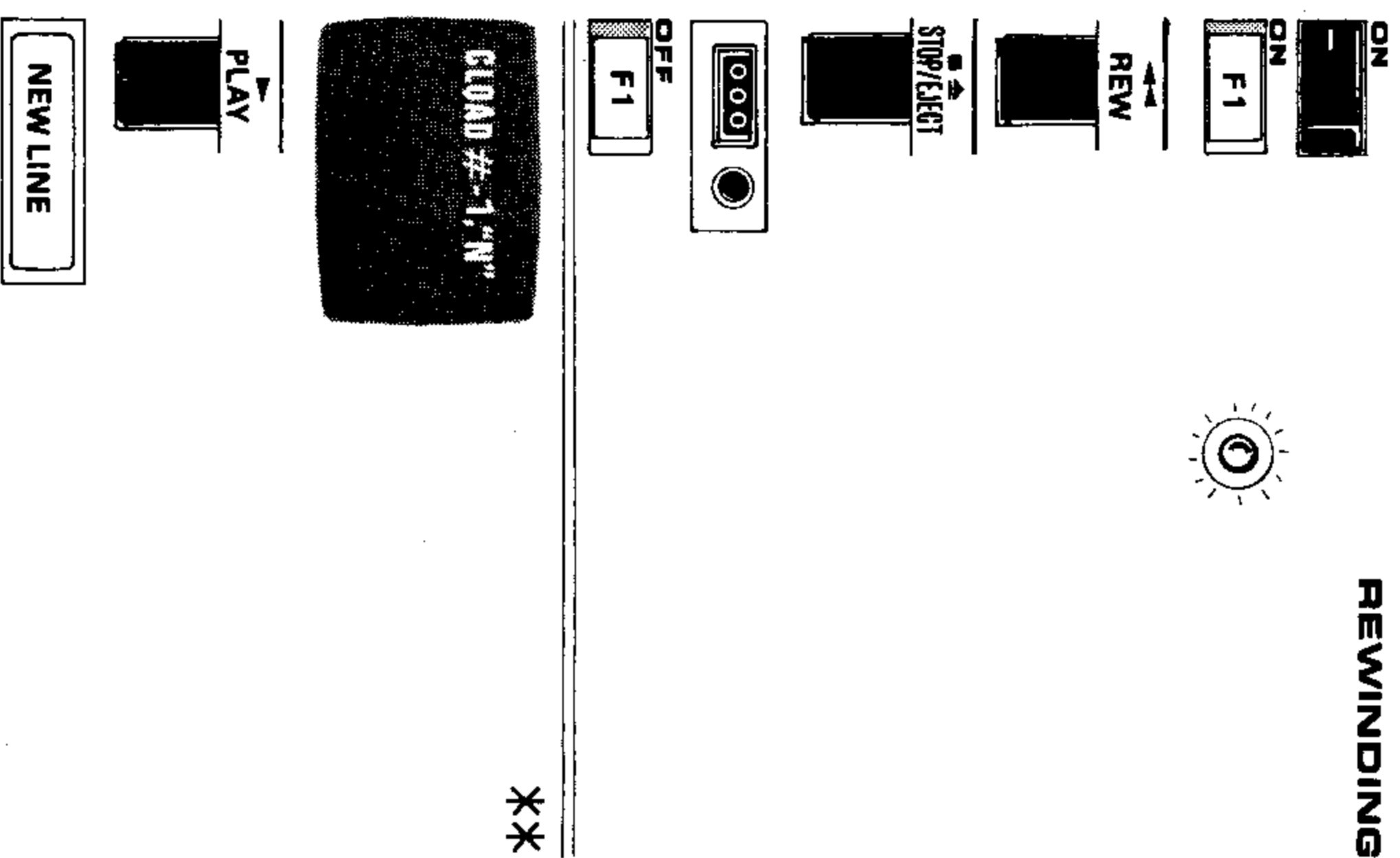

5.3 Checking a Program

- Read the CLOAD command (section 1.5 in the BASIC Manual.)
- Rewind the cassette tape to the starting point of the program.
- Press the PLAY button on the cassette drive.
- Type in the command CLOAD? from the keyboard.
- Hit the NEW LINE key.

Once the computer finds the program, two asterisks will appear on the top right corner of the display, the one on the right will be flashing if comparison is successful. A READY message will appear if the comparison has been completed. Otherwise, the word BAD will be displayed.

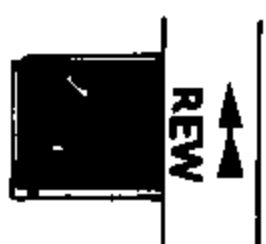

**
or
BAD

5.4 Listing and Executing a Program

- Read the LIST and RUN commands (sections 1.9 and 1.11 in the BASIC Manual).
- Type in LIST and hit the NEW LINE key (The entire program will be listed on the display).
- Type in RUN and hit the NEW LINE key (The computer starts executing the program).

WARNING : CASSETTE LOADING

Although the cassette interface circuit can tolerate wide range of input signal level, sometimes, loading error may occur. The reason is that so many software houses produce TRS-80 compatible tapes and their quality may differ a lot. The only solution is to do a backup for yourself and use the backup copy for future loading.

The backup procedure should be:—

- Put the TRS-80 compatible tape into second cassette.
- Connect the second cassette to the computer.
- Use CLOAD #-2, 'F' command to load the program into memory.
- Try to adjust the second cassette volume if loading fails.
- If the program is successfully loaded, save it onto a blank tape with cassette # 1.



PROGRAM SAVING 6

6.1 Winding the Tape to the Proper Location

- a) Press the F 1 key (the red light labelled CASSETTE RECORDER should be on as well).
- b) Press the REWIND or FAST FORWARD key and set the tape to the location where program saving starts.
- c) Press the STOP/EJECT key to physically stop tape winding operations.
- d) Press the RECORD and PLAY keys simultaneously, to clear a part of the tape before actual saving.
- e) Rewind the tape a little to ensure the entry point for program saving is clear.
- f) Release the F 1 key (the red light labelled CASSETTE RECORDER should be off).

6.2 Program Saving

- a) Type in CSAVE #-1, "N" (where N represents a file name).
- b) Press the RECORD and PLAY key simultaneously.
- c) Hit the NEW LINE key.

The red light labelled CASSETTE RECORDER should be turned on automatically, and the cassette should be recording the signal from the computer. However, no asterisk will appear on the display. A ready message will be displayed after the saving has completed.

6.3 Program Checking

After the program has been saved on tape, it is necessary to check whether the program on tape is a true copy of the one in the computer. Program checking is provided in the System 80. Please read section 5.3, "CHECKING A PROGRAM".

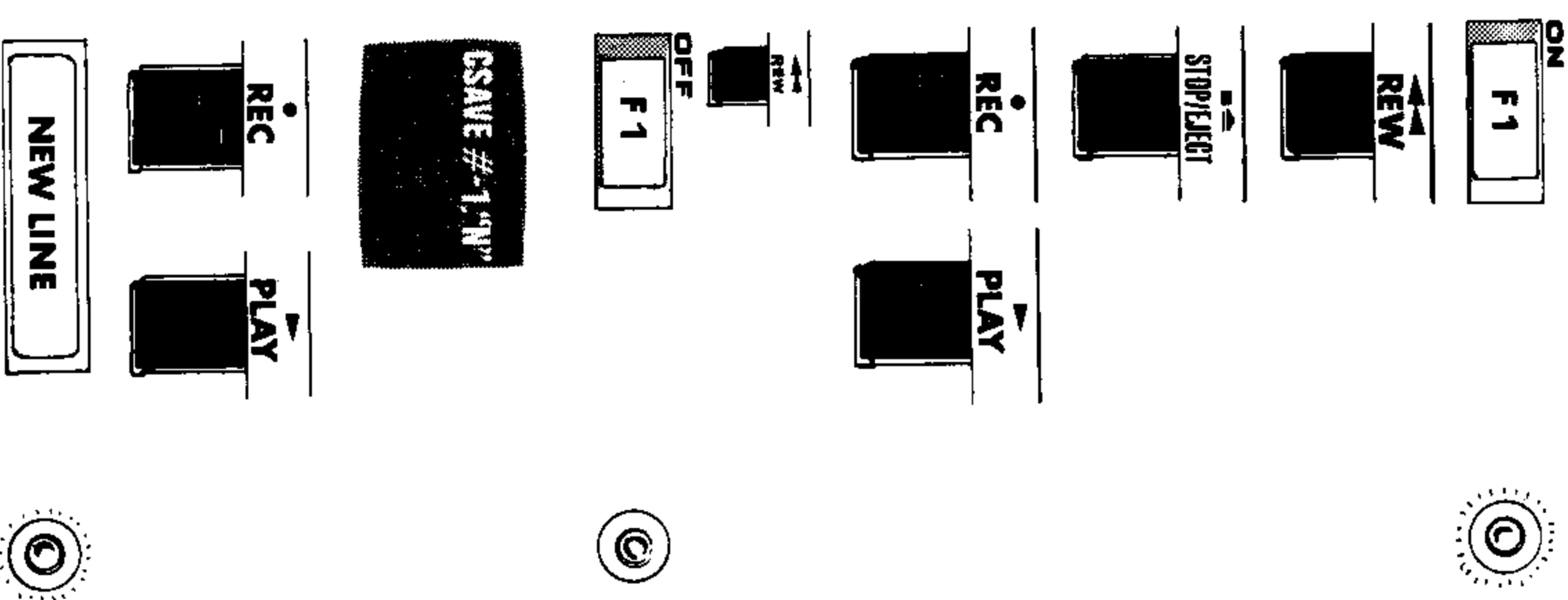

SECOND CASSETTE RECORDER

7

Two cassette recorders are required in some applications such as payroll and accounting. In these applications, old data have to be read into the computer sequentially from one file and output to another file after processing or updating. The main unit already has the interface for one more cassette recorder. Signal input/output is through the DIN jack at the back panel. A cassette recorder cable is packed with the System.

Active Commands and instructions are provided to handle this extra cassette. These are : —

- (i) CLOAD # -2, "M" — load a program called M from cassette '2'.
- (ii) CSAVE # -2, "M" — save a program onto cassette '2'.
- (iii) PRINT# -2, A, B, C\$ — store the variables A, B and character string C\$ onto cassette '2'.
- (iv) INPUT# -2, A, B, C\$ — input the variables A, B and character string C\$ from cassette '2'.

For further programming details, please refer to the BASIC Manual. The operating procedure of the cassette '2' for playing (reading in data) or recording (outputting data onto the tape) is same as that described in 4.1

Note: — The user may have to adjust output volume of his cassette until no error occurs during cassette loading. The System 80 may have to be reset if invalid data is read and causes a dead loop.

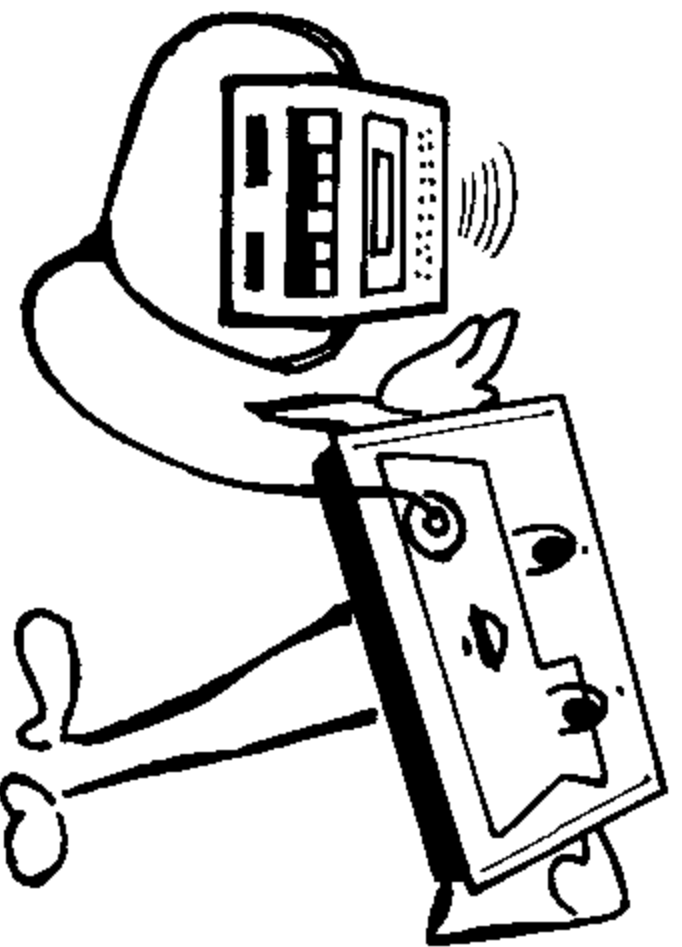

~That's my heart-beat!!~

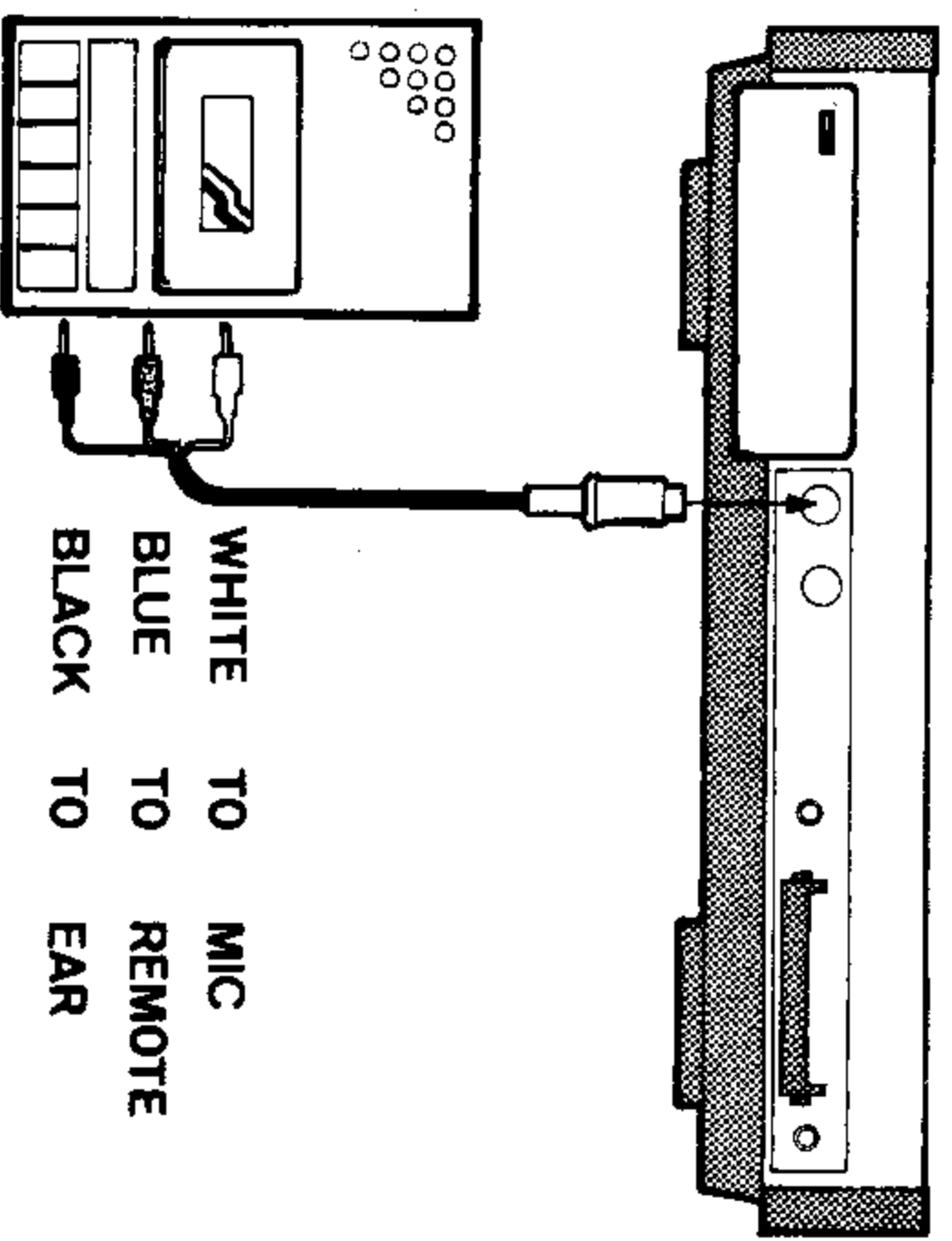

SYSTEM RESET

8

The system must, in some cases be reset. When, for example, the machine is running in a dead loop. The Reset Switch is located at the right side of the back panel. Pressing the reset switch causes the computer to return to the 'READY' mode without changing the memory contents.

The system runs in a dead loop in the following cases:

- (1) loading a program from the cassette which contains an invalid file, or when the volume of the recorder is poorly adjusted.
- (2) executing LPRINT or LLIST instructions without hooking up a printer to the system or having not turned on the printer.
- (3) executing an inappropriate POKE instruction.

The CPU is reset everytime when the power is on. Turning the system off and on immediately is not a good practice; because it may cause improper initialization of the CPU. Therefore, the user should wait for about 15 seconds before turning on the system again.

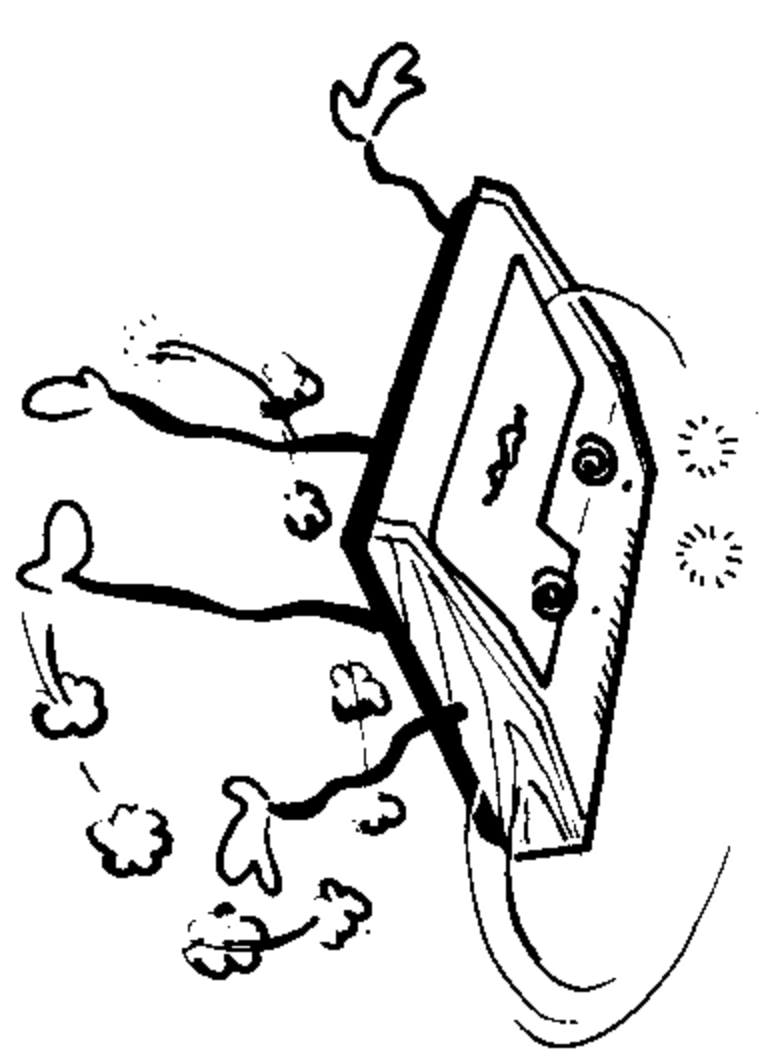

SOFTWARE

9

The System 80 operates on a high level language called BASIC. The system's Extended BASIC is compatible with that of TRS-80 Level II BASIC. Therefore, TRS-80's tapes can be loaded into the system and run. Further details of the BASIC language are explained in the BASIC Manual.

The System can also load binary tapes that contain Z80 machine codes. For loading such tapes, please refer to the SYSTEM command discussed in the BASIC MANUAL.

(1) ELECTRICAL CHARACTERISTICS

APPENDIX A

TECHNICAL SPECIFICATIONS

POWER CONSUMPTION	- 25W (MAX.)
CASSETTE INPUT LEVEL	- 1 V peak to peak
COMPUTER OUTPUT RECORDING LEVEL	- 0.3 V peak to peak
REMOTE SWITCHING CAPACITY	- 0.5 A max at 6 V DC
VIDEO OUTPUT	- 2V peak to peak (Negative sync pulse)

(2) CONNECTORS PIN ASSIGNMENTS

DIN JACK PIN CONNECTIONS FOR ADDITIONAL CASSETTE

- 1 - REMOTE
- 2 - SIGNAL GROUND
- 3 - REMOTE
- 4 - INPUT
- 5 - OUTPUT

DIN JACK PIN CONNECTIONS FOR VIDEO INTERFACE

- 1 - +5 V
- 4 - VIDEO OUTPUT
- 5 - GROUND

DIN JACK VIEWED FROM REAR SIDE OF THE SYSTEM.

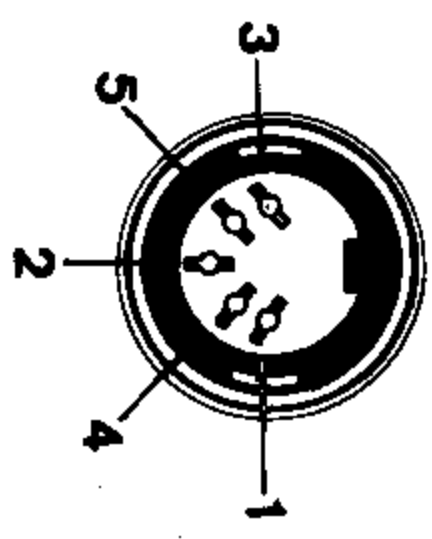

EXPANSION PIN EDGE VIEWED FROM REAR SIDE



PIN CONNECTIONS FOR EXPANSION INTERFACE

PIN	SIGNAL	DESCRIPTION	PIN	SIGNAL	DESCRIPTION
1	GND	GROUND	26	A10	
2	GND	GROUND	27	A13	
3	A7		28	A11	
4	A6		29	A12	
5	A5		30	PHI	1.79 MHz clock
6	A4		31	PINT	INTERRUPT
7	A1		32	NC	NO CONNECTION
8	A3		33	NC	NO CONNECTION
9	A2		34	PHLDA	PROCESSOR HOLD ACKNOWLEDGE
10	A0		35	PHANTOM	PHANTOM
11	D5		36	HALT	HALT ACKNOWLEDGE
12	D2		37	PWAIT	PROCESSOR WAIT
13	NC		38	IORQ	INPUT/OUTPUT REQUEST
14	D1		39	PHOLD	PROCESSOR HOLD
15	D0		40	WR	PROCESSOR WRITE
16	D3		41	RD	PROCESSOR READ
17	D7		42	CCDBS/STADBS	CONTROL AND STATUS BUS DISABLE
18	D6		43	MREQ	MEMORY REQUEST
19	VCC	+5V SUPPLY	44	DODBS/ADDDBS	DATA AND ADDRESS BUS DISABLE
20	D4		45	M1	FIRST STATE OF INSTRUCTION CYCLE
21	A15		46	RESET	CPU RESET
22	A8		47	RFSH	DYNAMIC MEMORY REFRESH
23	A14		48	NMI	NON-MASKABLE INTERRUPT
24	A9		49	GND	
25	NC	NO CONNECTION	50	GND	

MEMORY MAP

FFFF

7FFF

3C00-3FFF
3800-37FF

2FFF

0000

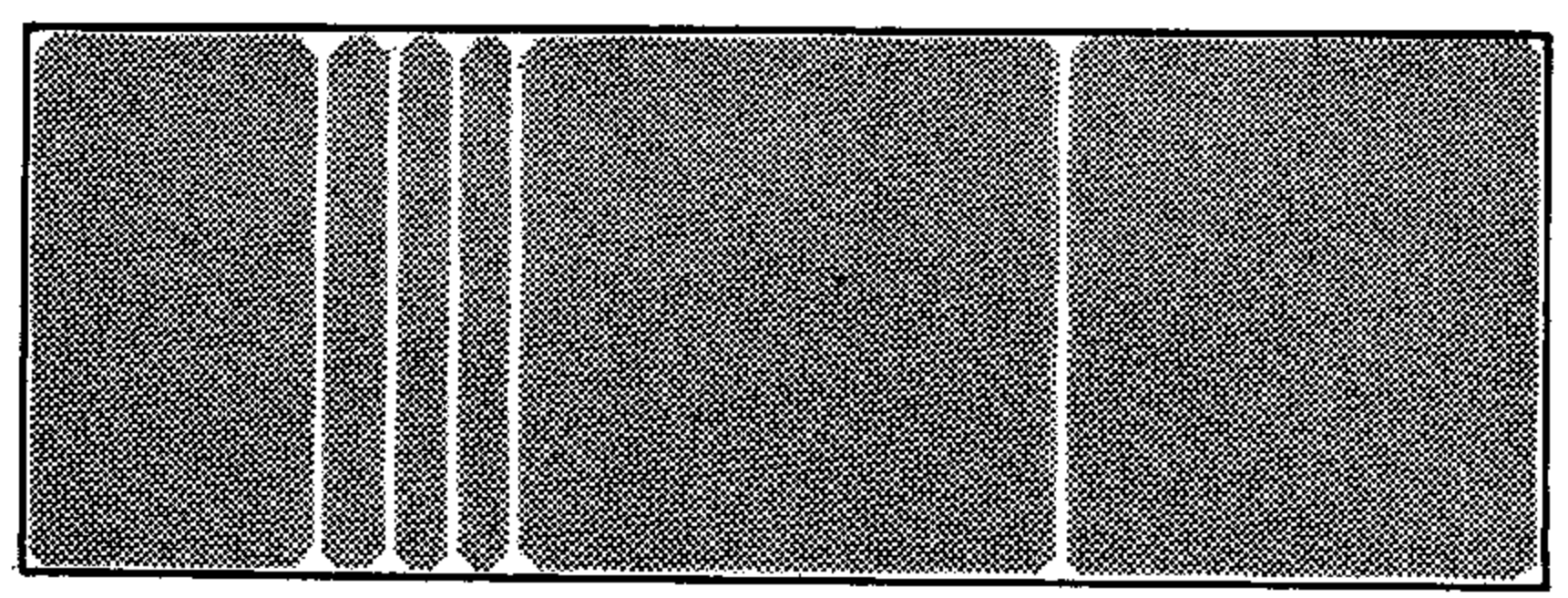

FOR EXPANSION

16K RAM

VIDEO DISPLAY MEMORY
RESERVED FOR KEYBOARD

ROM

APPENDIX B MEMORY MAP & I/O MAP

I/O PORT ASSIGNMENT

CASSETTE INTERFACE - FF, FE
PRINTER INTERFACE - FD

APPENDIX C

ASCII TABLE

HEX	DECIMAL	CHARACTER	HEX	DECIMAL	CHARACTER
OD	13	CR (AUTO LF)	40	64	@
20	32	SPACE	41	64	A
21	33	.	42	66	B
22	34	"	43	67	C
23	35	=	44	68	D
24	36	\$	45	69	E
25	37	%	46	70	F
26	38	&	47	71	G
27	39	'	48	72	H
28	40	(49	73	I
29	41)	4A	74	J
2A	42	*	4B	75	K
2B	43	+	4C	76	L
2C	44	,	4D	77	M
2D	45	-	4E	78	N
2E	46	.	4F	79	O
2F	47	/	50	80	P
30	48	0	51	81	Q
31	49	1	52	82	R
32	50	2	53	83	S
33	51	3	54	84	T
34	52	4	55	85	U
35	53	5	56	86	V
36	54	6	57	87	W
37	55	7	58	88	X
38	56	8	59	89	Y
39	57	9	5A	90	Z
3A	58	:	5B	91	[
3B	59	;	5C	92	\
3C	60	<	5D	93]
3D	61	=	5E	94	^
3E	62	>	5F	95	_
3F	63	?			

SYSTEM 80 USER'S MANUAL

(Attach to System 80 user's manual)

Introduction

This is an enhanced version of System 80. An 1.5K ROM is added to provide new keyboard and display functions, statement renumber command, and a machine language monitor.

New keyboard and display functions, and the monitor will be discussed in the following pages. The Renumber command is described in the Active Command section of the BASIC manual. For power up procedure, cassette operations and other system features, please refer to the old user's manual.

Enable the 1.5K ROM routines

The computer is fitted with an exclusive 1.5K extension to the Microsoft 12K BASIC, featuring upper and lower case, flashing cursor, auto repeat keyboard, screen print, machine language monitor, and renumber functions.

To use these functions, the BASIC extension should be initialised immediately after the machine entering BASIC Active Command level:

The initialisation procedure is

- i) type SYSTEM **NEWLINE**
- ii) reply *?
- iii) type/12288 **NEWLINE**
- iv) A flashing cursor will show on the screen.

The entry address 12288 used in step (iii) will enable all the ROM facilities. If you just want part of them, there are two other choices. Enter address 12299 will retain all the facilities except flashing cursor. Enter address 12294 will have lower case facility only.

New Keyboard functions

Input lower case characters

Lower case characters can be input by hitting the character key with the SHIFT key depressed.

Repeat Key

After pressing a key longer than one second, the computer automatically repeats entering that character until the key is released.

Print Screen

By hitting SHIFT -  - P, the computer will transfer the information displayed on the screen to the printer. If no printer is connected or the printer is turned off, the computer will skip the printing process instead of locking up itself in waiting. Once the SCREEN PRINT function is activated, both alphanumeric and graphic characters on the screen will transfer to the printer. Only **those printers that can recognise System 80** or TRS-80 graphic characters are able to print the graphics. Otherwise, only alphanumeric characters can be printed.

Disabled flashing cursor

A flashing cursor can attract the operations attention, however, somebody may feel it frustrating.

In order to disable the flashing cursor, hit SHIFT-BREAK. To enable it, hit SHIFT-BREAK again. If you don't want a flashing cursor at the start, please enter 12299 instead of 12288 during ROM initialization.

Machine Language Monitor

The machine language monitor allows you to enter, modify, display and execute (with breakpoints) Z80 machine code which is displayed and entered in hexadecimal format.

To enter the monitor, type SYSTEM NEWLINE and then / 12710 NEWLINE The machine will then show the current status of the CPU registers.

Five commands are available:

1. B Return to BASIC

typing B will return the machine to BASIC without altering memory contents.

2. D Display memory

This command has the form Dnnnn where nnnn is an address in hexadecimal. e.g. D4545 will display the contents of 16 memory locations starting from address 4545.

Use of the down arrow key will then display successive sets of 16 locations, the up arrow key will step back through the memory.

Use any other key to exit to the display of register contents.

3. R Modify registers

This command allows modification of any of the Z80 registers.

Pressing R will cause a display of the first register pair (IY) -- the next four characters typed will be entered into the register, use the X key to skip to the next register pair.

e.g. type R
display IY 8999/
type ABCD
display IY 8999/ABCD
IX 4025/

Register pair IY now contains ABCD and IX is ready to be modified. An automatic exit is performed after Program Counter (PC) has been modified.

4. M Modify memory

This command allows the modification of any RAM memory location.

The command has the form Mnnnn where nnnn is the first address to be modified.

e.g. type M4000
display 4000 C3-
type FF
display 4000 C3-FF
4001 96

Location 4000 has now been modified to FF. Use the X key to exit.

5. G Start execution

The G command starts execution of a program. Command format is Gnnn,xxxx
NEWLINE where nnnn is the start address and xxxx is the breakpoint address.
e.g. G0000 will boot up the machine.

G8000, 81AB the machine start execution from address 8000 and return to the monitor when it runs to the address 81AB.

The monitor creates a breakpoint by inserting an instruction 'CALL 3347H' into the breakpoint location. When the instruction is executed, all registers will be saved and the former instruction in the breakpoint location will then be restored. Very often in program debugging, the program runs into a dead loop or other happenings, the breakpoint is not encountered. The user has to reset the computer to start again. However, the three bytes CALL instruction still remains in the user program. The only way to restore the original codes is by the M command, or by the POKE instruction in BASIC.

''Note: It is not possible to CSAVE machine language programmes
which have been made in the monitor''

VOLUME ADJUSTMENT FOR IMPROVEMENT OF CASSETTE LOADING

In order to rectify the cassette loading problem caused by differences in output level and quality of different cassette tapes, your system now has a volume and a level meter added on the cassette recorder.

The volume adjustment procedure is:—

- (1) Press 'F1', power is applied to the cassette recorder.
- (2) Put in your cassette tape.
- (3) Wind or rewind the tape until the counter indicates the program's start.
- (4) Press the PLAY key.
- (5) Turn the volume towards the 'HIGH' side.
- (6) When the program signal comes, the meter deflects, and the volume should be adjusted to an adequate level.
- (7) Rewind the tape to the program's start and load the cassette into the computer.

Volume should not be adjusted during cassette loading.

The recommended level for better loading is at middle range (around 2-3 on the meter). However if the loading is unsuccessful, you should try with higher or lower level. If it still can't be loaded, your program may be damaged.

